

# Polarity: Bonds & Molecules

**DR. MIOY T. HUYNH**  
YALE UNIVERSITY  
CHEMISTRY 161  
FALL 2019

[www.mioy.org/chem161](http://www.mioy.org/chem161)

## ELECTRONEGATIVITY (EN)

*The ability for an atom to attract electrons to itself.*

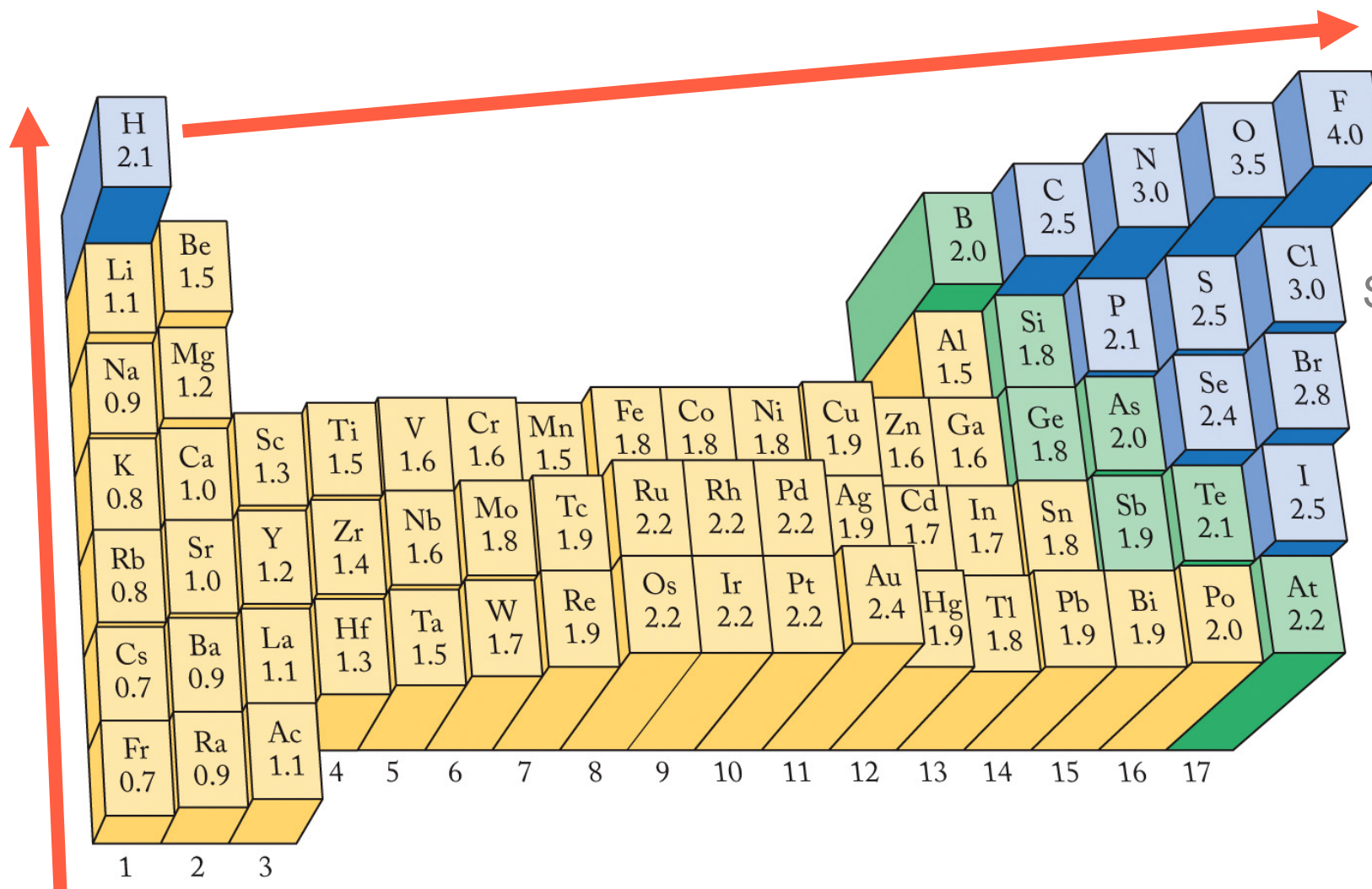

Same trend as ionization energy (IE)!

EN decreases down a column.  
EN increases across a row.

## ELECTRONEGATIVITY (EN)

*The ability for an atom to attract electrons to itself.*

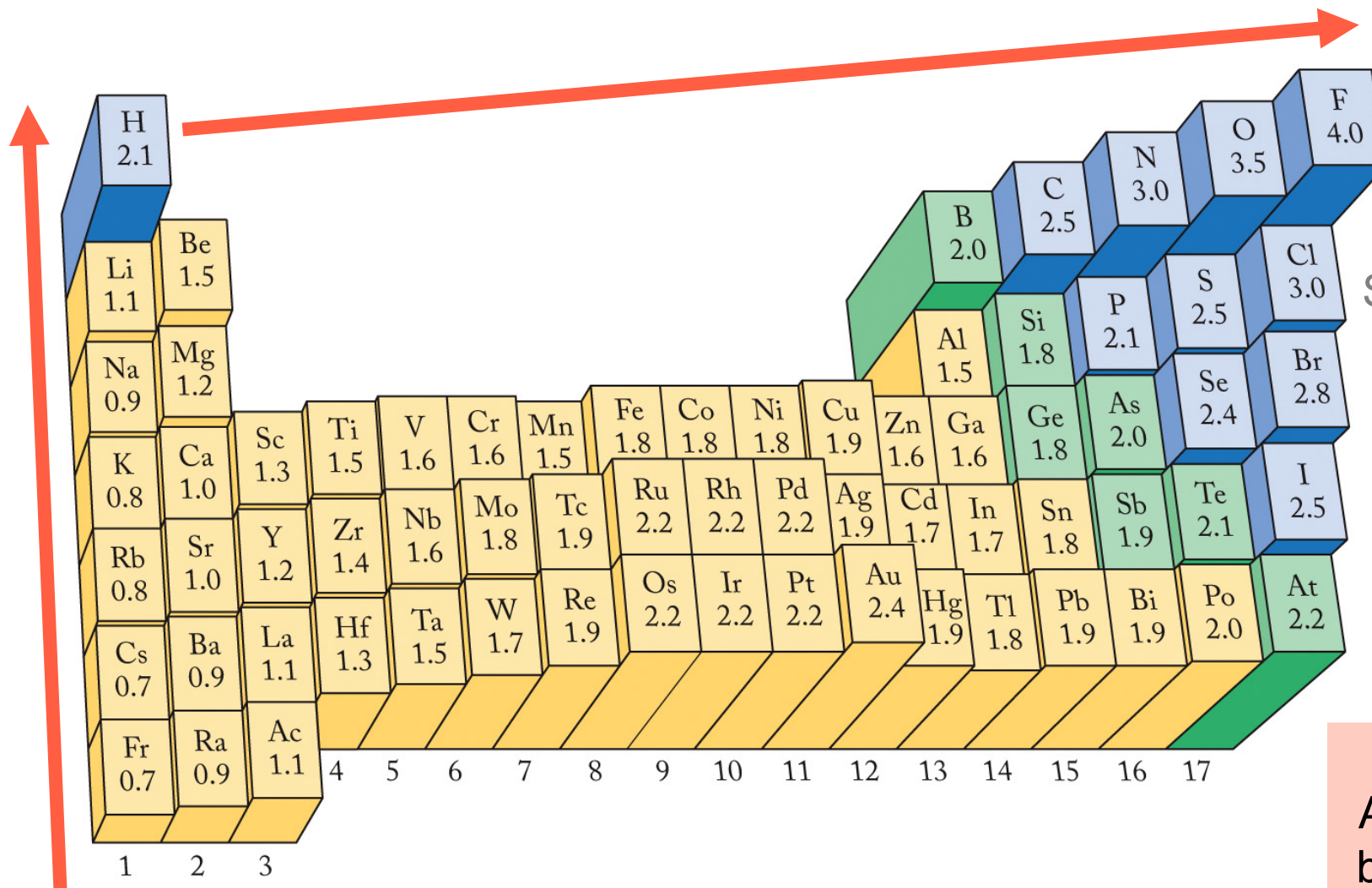

Same trend as ionization energy (IE)!

EN decreases down a column.  
EN increases across a row.

## BOND POLARITY

An unequal sharing of electrons in a bond when difference in EN is large.

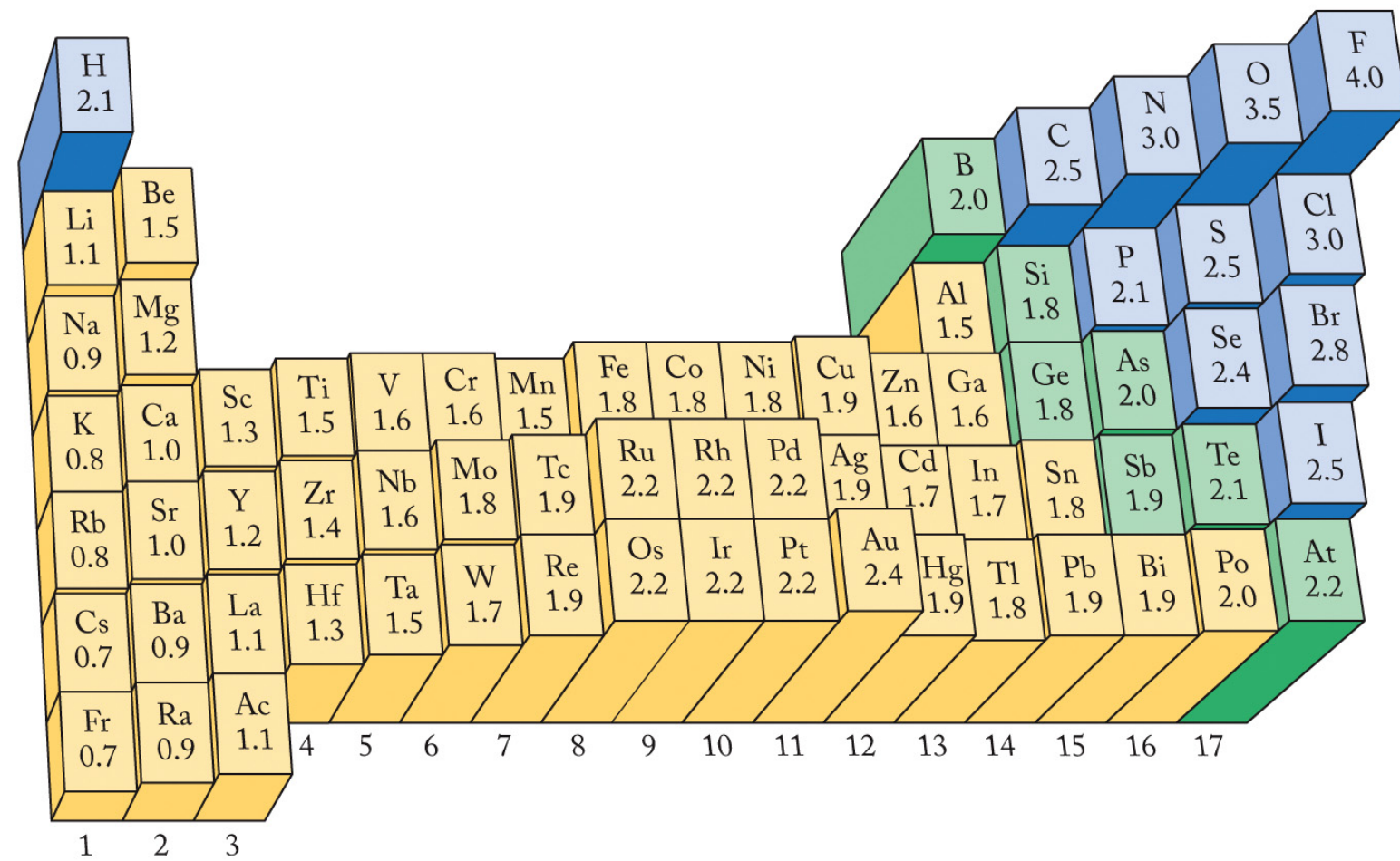

## BOND POLARITY

An unequal sharing of electrons in a bond when difference in EN ( $\Delta EN$ ) is large.

Which is the most polar bond type?

C–Se

C=O

Cl–Br

O=O

N–H

C–H

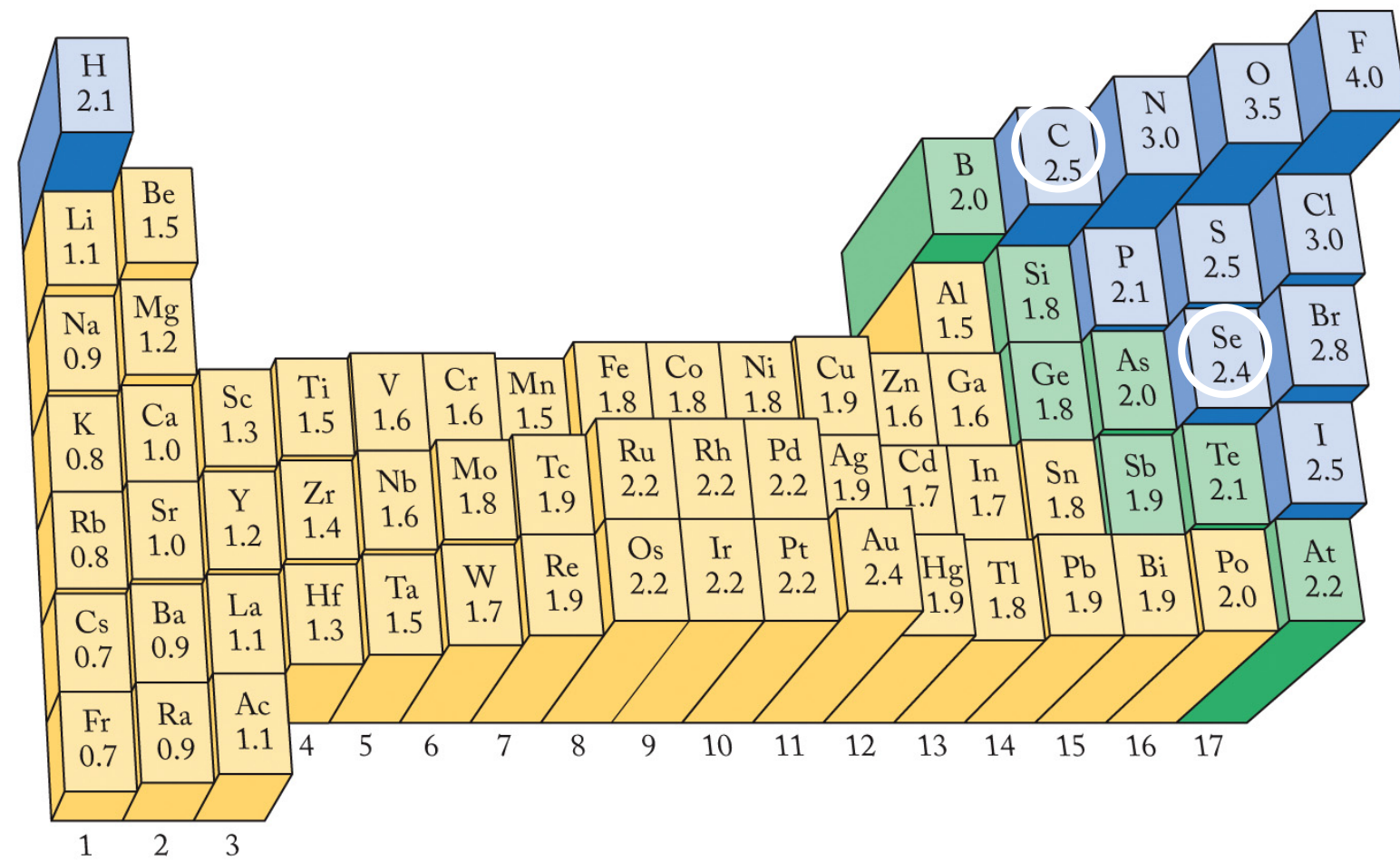

## BOND POLARITY

An unequal sharing of electrons in a bond when difference in EN ( $\Delta EN$ ) is large.

Which is the most polar bond type?

$$\text{C–Se} \quad \Delta EN = 2.5 - 2.4 = 0.1$$

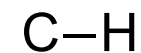
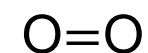
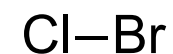
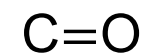

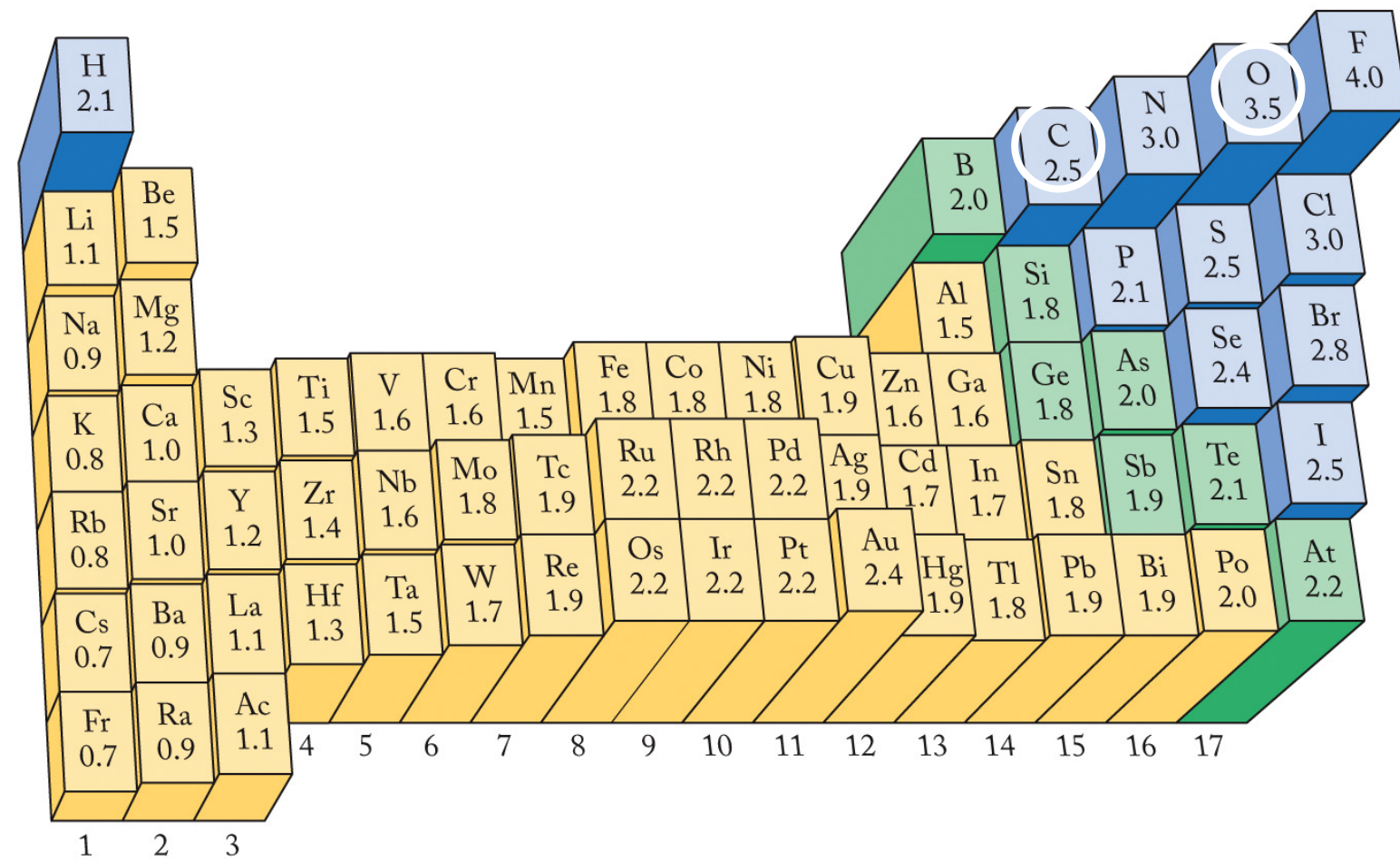

## BOND POLARITY

An unequal sharing of electrons in a bond when difference in EN ( $\Delta EN$ ) is large.

Which is the most polar bond type?

$$\text{C–Se} \quad \Delta EN = 2.5 - 2.4 = 0.1$$

$$\text{C=O} \quad \Delta EN = 3.5 - 2.5 = 1.0$$

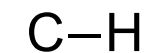
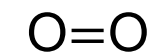
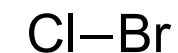

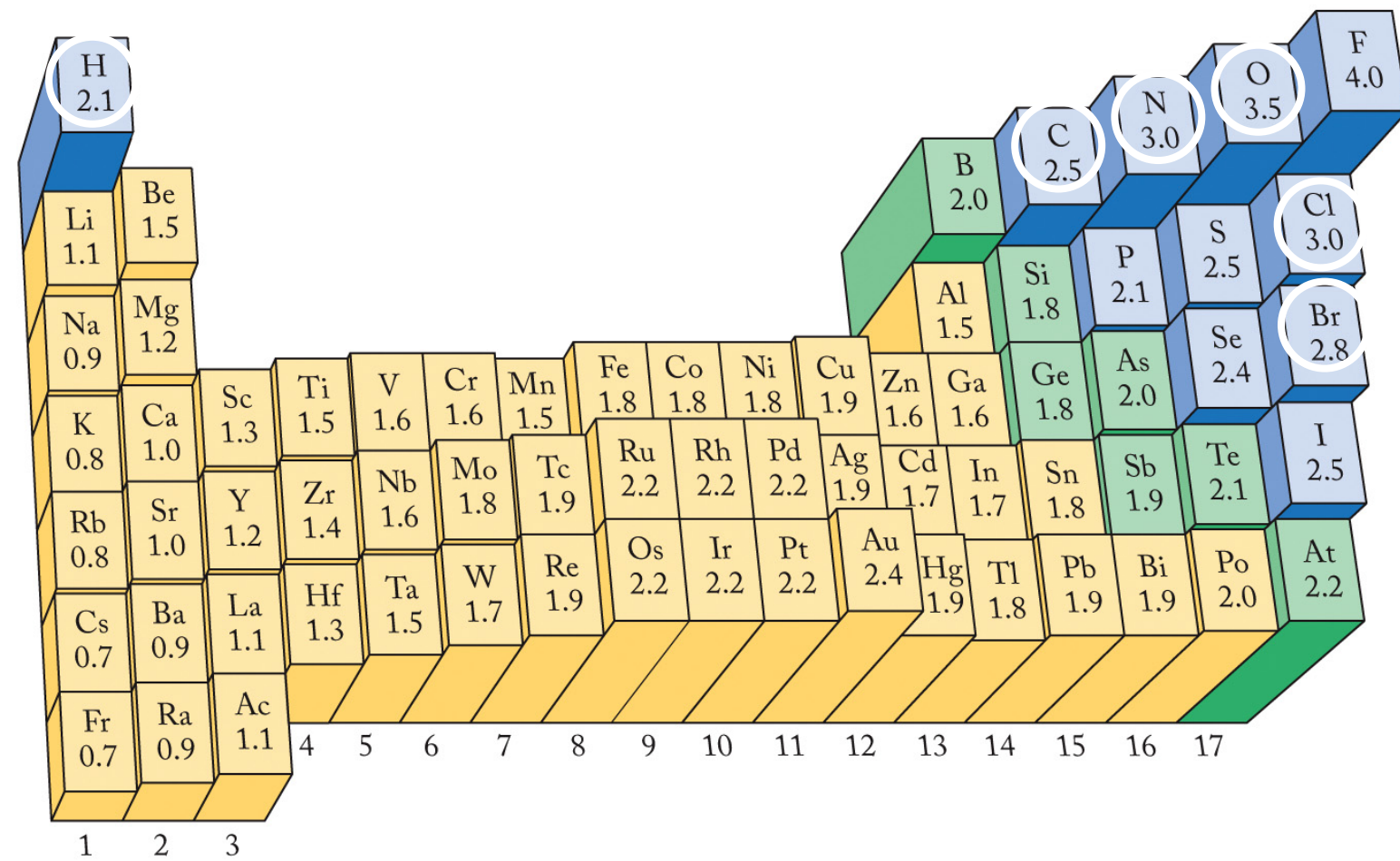

## BOND POLARITY

An unequal sharing of electrons in a bond when difference in EN ( $\Delta EN$ ) is large.

Which is the most polar bond type?

$$\text{C–Se} \quad \Delta EN = 2.5 - 2.4 = 0.1$$

$$\text{C=O} \quad \Delta EN = 3.5 - 2.5 = 1.0$$

$$\text{Cl–Br} \quad \Delta EN = 3.0 - 2.8 = 0.2$$

$$\text{O=O} \quad \Delta EN = 3.5 - 3.5 = 0.0$$

$$\text{N–H} \quad \Delta EN = 3.0 - 2.1 = 0.9$$

$$\text{C–H} \quad \Delta EN = 2.5 - 2.1 = 0.4$$

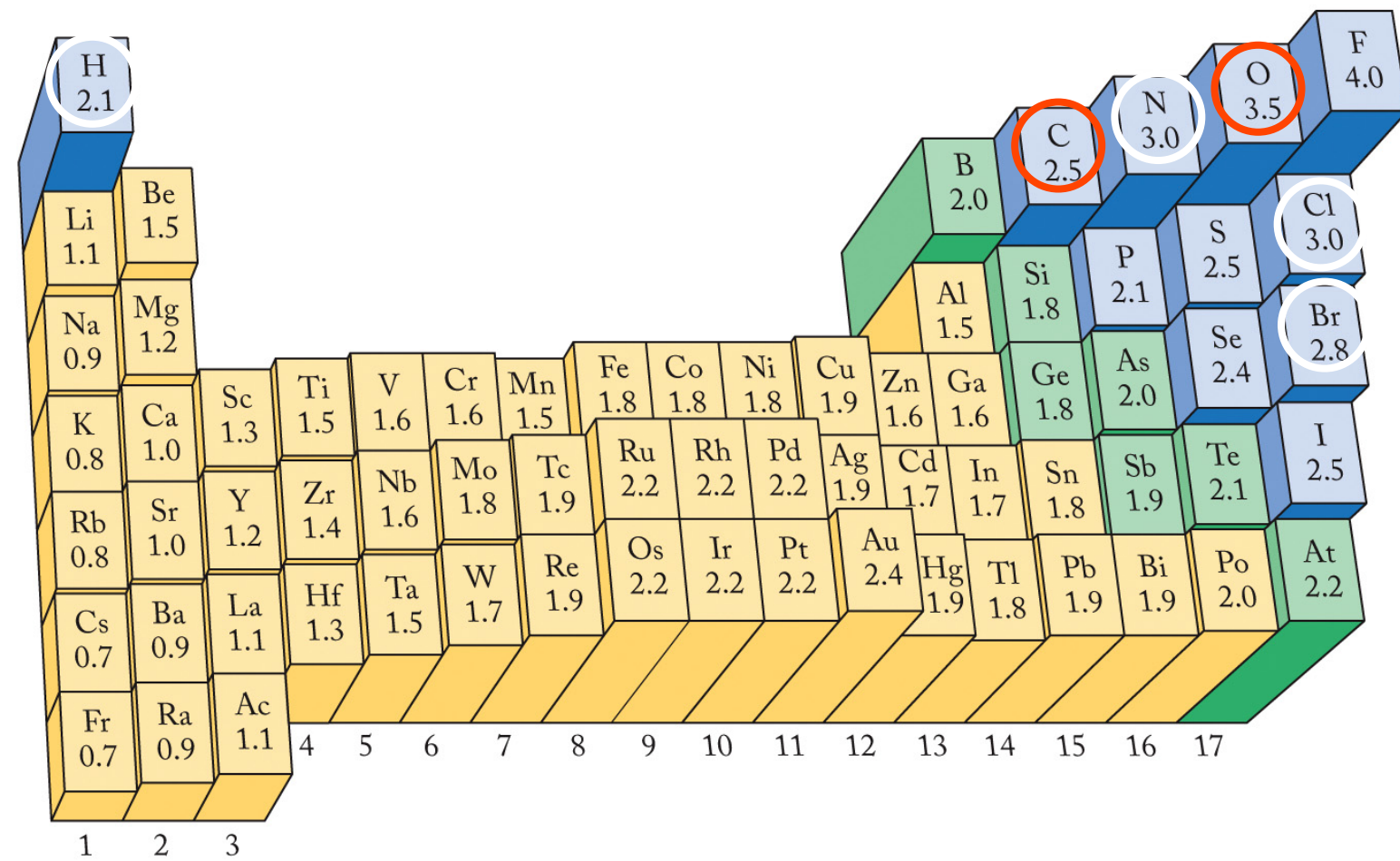

## BOND POLARITY

An unequal sharing of electrons in a bond when difference in EN ( $\Delta EN$ ) is large.

Which is the most polar bond type?

$$\text{C–Se} \quad \Delta EN = 2.5 - 2.4 = 0.1$$

$$\text{C=O} \quad \Delta EN = 3.5 - 2.5 = 1.0$$

$$\text{Cl–Br} \quad \Delta EN = 3.0 - 2.8 = 0.2$$

$$\text{O=O} \quad \Delta EN = 3.5 - 3.5 = 0.0$$

$$\text{N–H} \quad \Delta EN = 3.0 - 2.1 = 0.9$$

$$\text{C–H} \quad \Delta EN = 2.5 - 2.1 = 0.4$$



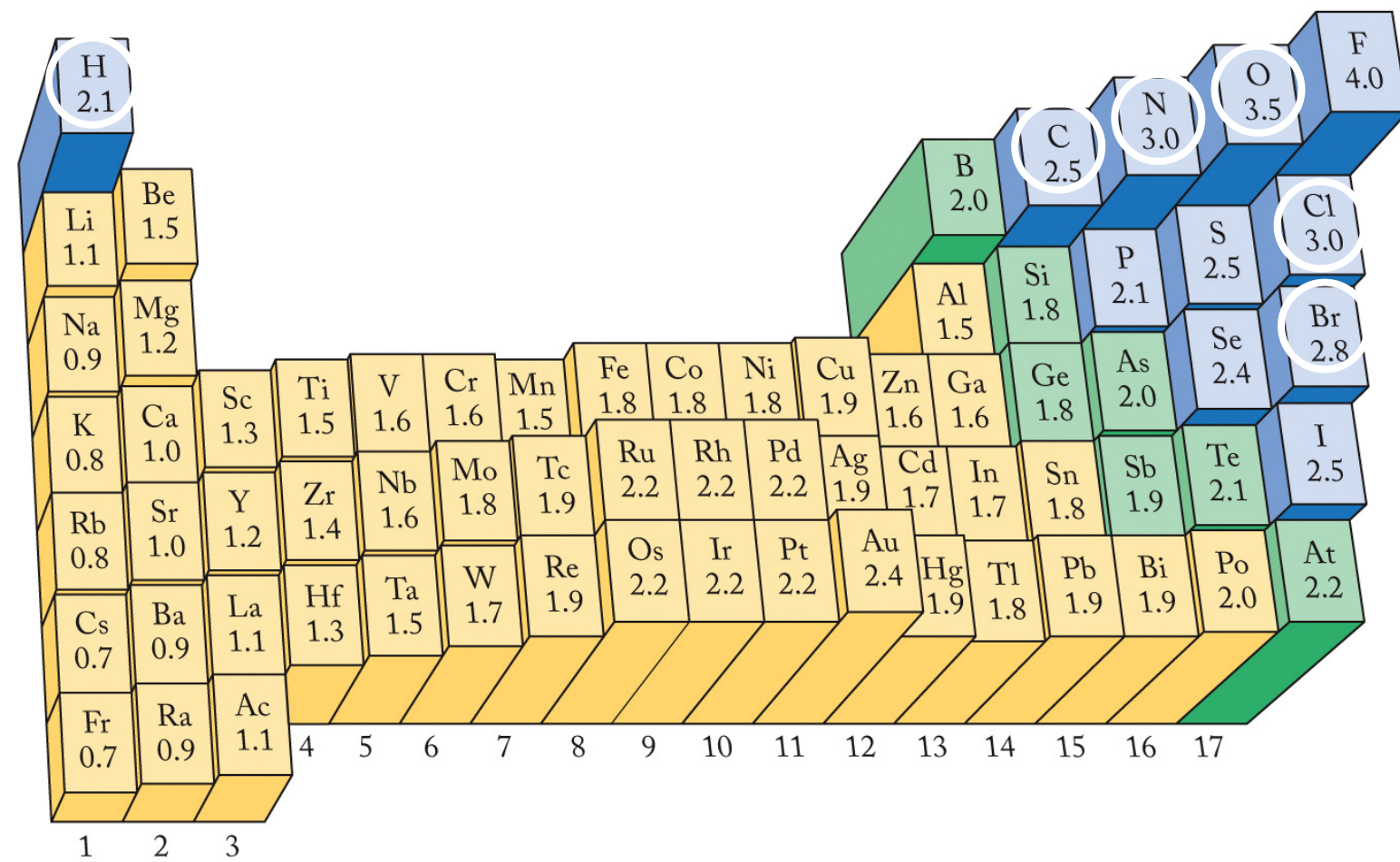

## BOND POLARITY

An unequal sharing of electrons in a bond when difference in EN ( $\Delta EN$ ) is large.

Which is the least polar bond type?

C–Se  $\Delta EN = 2.5 - 2.4 = 0.1$

C=O  $\Delta EN = 3.5 - 2.5 = 1.0$

Cl–Br  $\Delta EN = 3.0 - 2.8 = 0.2$

O=O  $\Delta EN = 3.5 - 3.5 = 0.0$

N–H  $\Delta EN = 3.0 - 2.1 = 0.9$

C–H  $\Delta EN = 2.5 - 2.1 = 0.4$

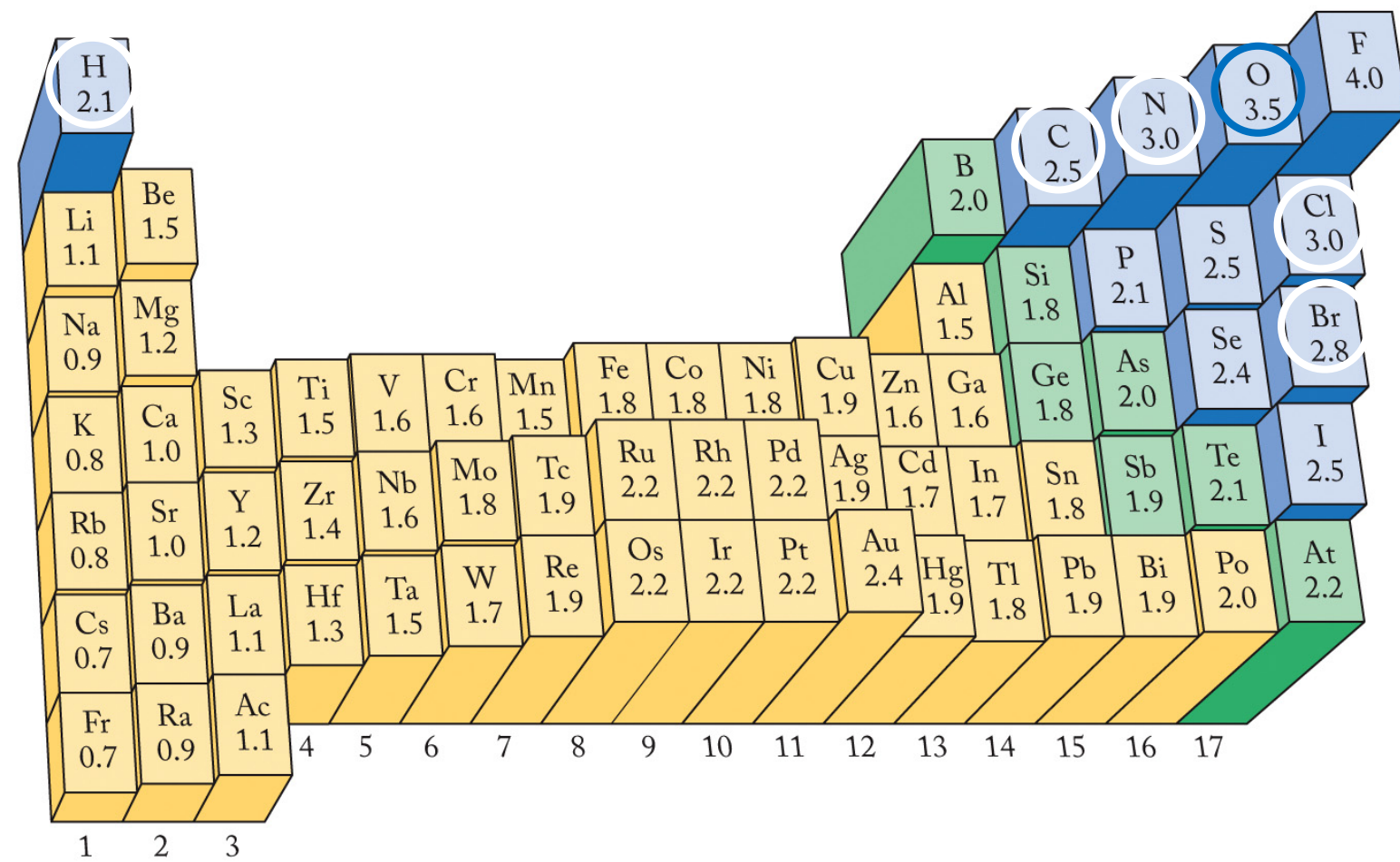

## BOND POLARITY

An unequal sharing of electrons in a bond when difference in EN ( $\Delta EN$ ) is large.

Which is the **least** polar bond type?

C–Se  $\Delta EN = 2.5 - 2.4 = 0.1$

C=O  $\Delta EN = 3.5 - 2.5 = 1.0$

Cl–Br  $\Delta EN = 3.0 - 2.8 = 0.2$

O=O  $\Delta EN = 3.5 - 3.5 = 0.0$

N–H  $\Delta EN = 3.0 - 2.1 = 0.9$

C–H  $\Delta EN = 2.5 - 2.1 = 0.4$

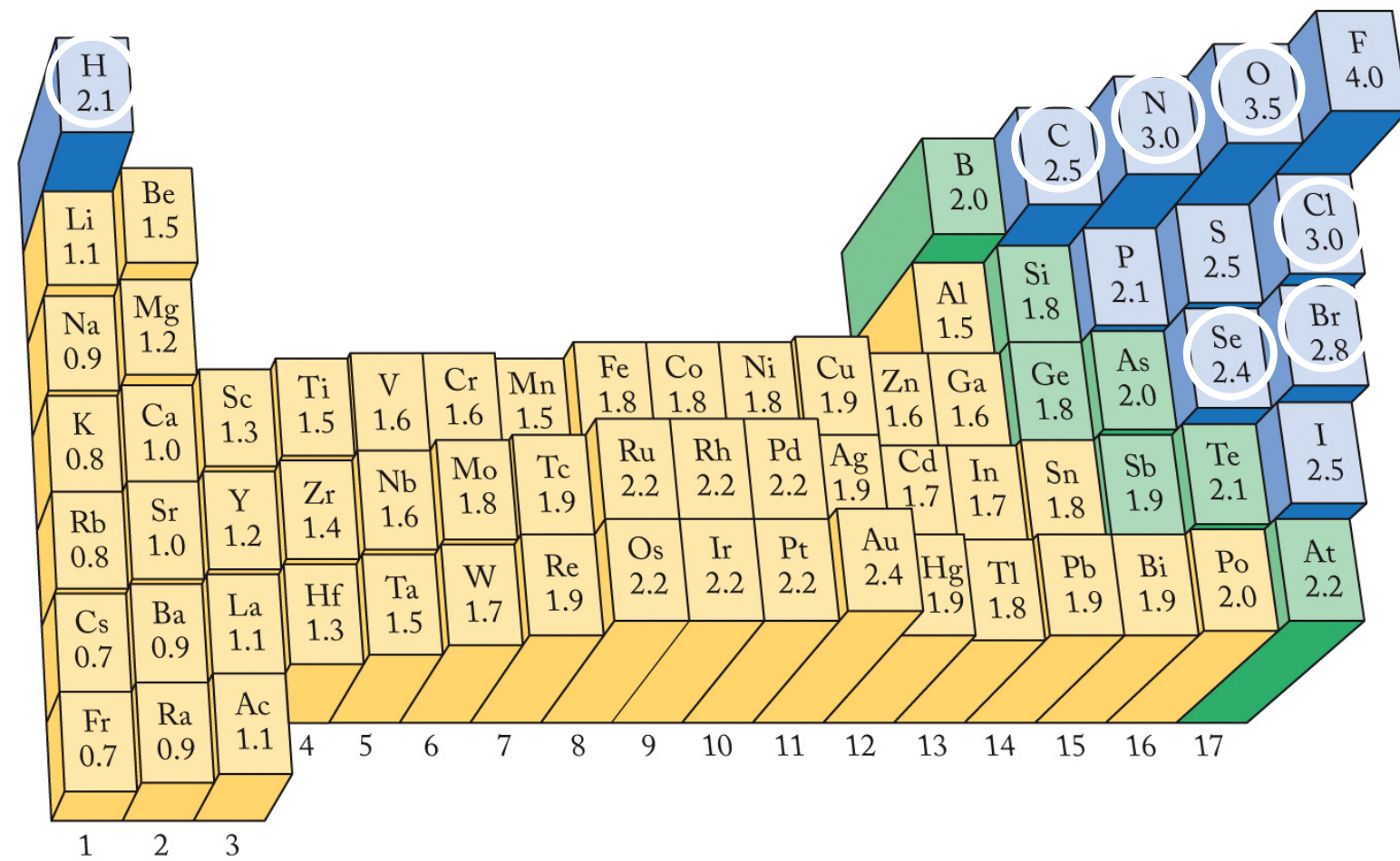

## BOND POLARITY

An unequal sharing of electrons in a bond when difference in EN ( $\Delta EN$ ) is large.

Draw the **bond dipole** for each:

$$\text{C}-\text{Se} \quad \Delta EN = 2.5 - 2.4 = 0.1$$

$$\text{C}=\text{O} \quad \Delta EN = 3.5 - 2.5 = 1.0$$

$$\text{Cl}-\text{Br} \quad \Delta EN = 3.0 - 2.8 = 0.2$$

$$\text{O}=\text{O} \quad \Delta EN = 3.5 - 3.5 = 0.0$$

$$\text{N}-\text{H} \quad \Delta EN = 3.0 - 2.1 = 0.9$$

$$\text{C}-\text{H} \quad \Delta EN = 2.5 - 2.1 = 0.4$$

## BOND DIPOLE

An arrow pointing from the less EN to the more EN atom.

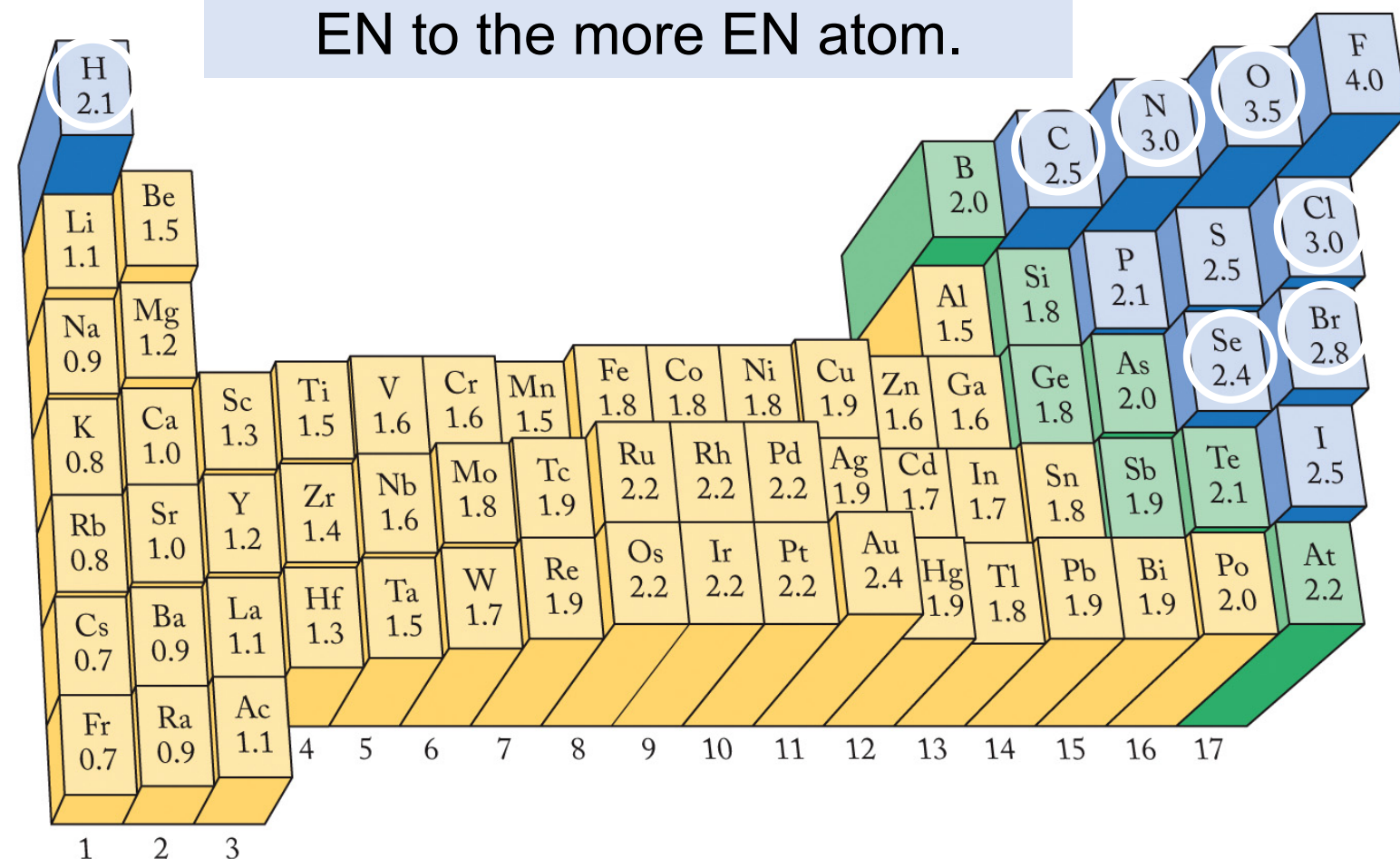

## BOND POLARITY

An unequal sharing of electrons in a bond when difference in EN ( $\Delta EN$ ) is large.

Draw the **bond dipole** for each:

$$\text{C}-\text{Se} \quad \Delta EN = 2.5 - 2.4 = 0.1$$

$$\text{C}=\text{O} \quad \Delta EN = 3.5 - 2.5 = 1.0$$

$$\text{Cl}-\text{Br} \quad \Delta EN = 3.0 - 2.8 = 0.2$$

$$\text{O}=\text{O} \quad \Delta EN = 3.5 - 3.5 = 0.0$$

$$\text{N}-\text{H} \quad \Delta EN = 3.0 - 2.1 = 0.9$$

$$\text{C}-\text{H} \quad \Delta EN = 2.5 - 2.1 = 0.4$$

## BOND DIPOLE

An arrow pointing from the less EN to the more EN atom.

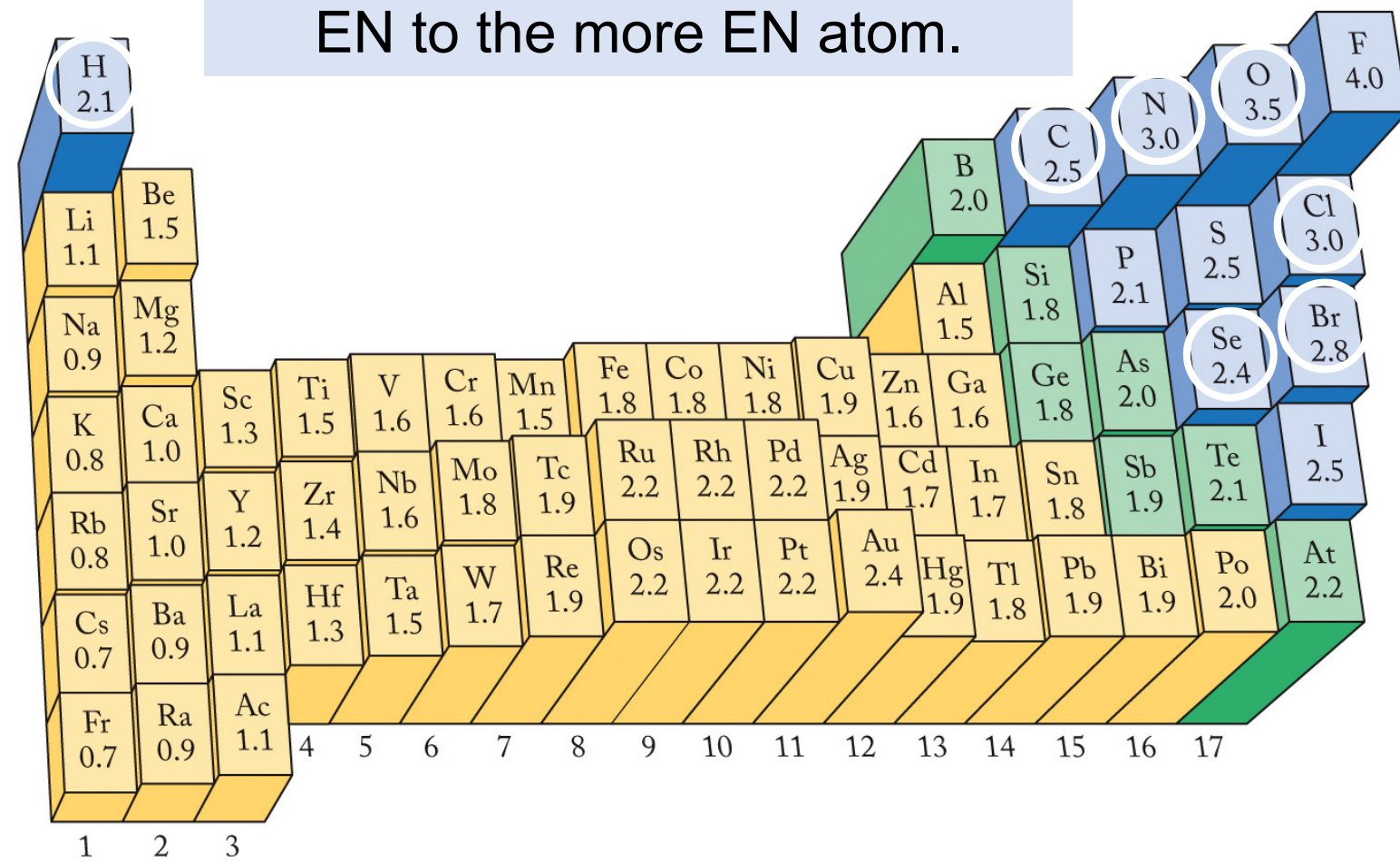

## BOND POLARITY

An unequal sharing of electrons in a bond when difference in EN ( $\Delta EN$ ) is large.

Draw the **bond dipole** for each:



C–Se  $\Delta EN = 2.5 - 2.4 = 0.1$



C=O  $\Delta EN = 3.5 - 2.5 = 1.0$



Cl–Br  $\Delta EN = 3.0 - 2.8 = 0.2$

*no bond dipole (nonpolar)*

O=O  $\Delta EN = 3.5 - 3.5 = 0.0$



N–H  $\Delta EN = 3.0 - 2.1 = 0.9$



C–H  $\Delta EN = 2.5 - 2.1 = 0.4$

## BOND DIPOLE

An arrow pointing from the less EN to the more EN atom.

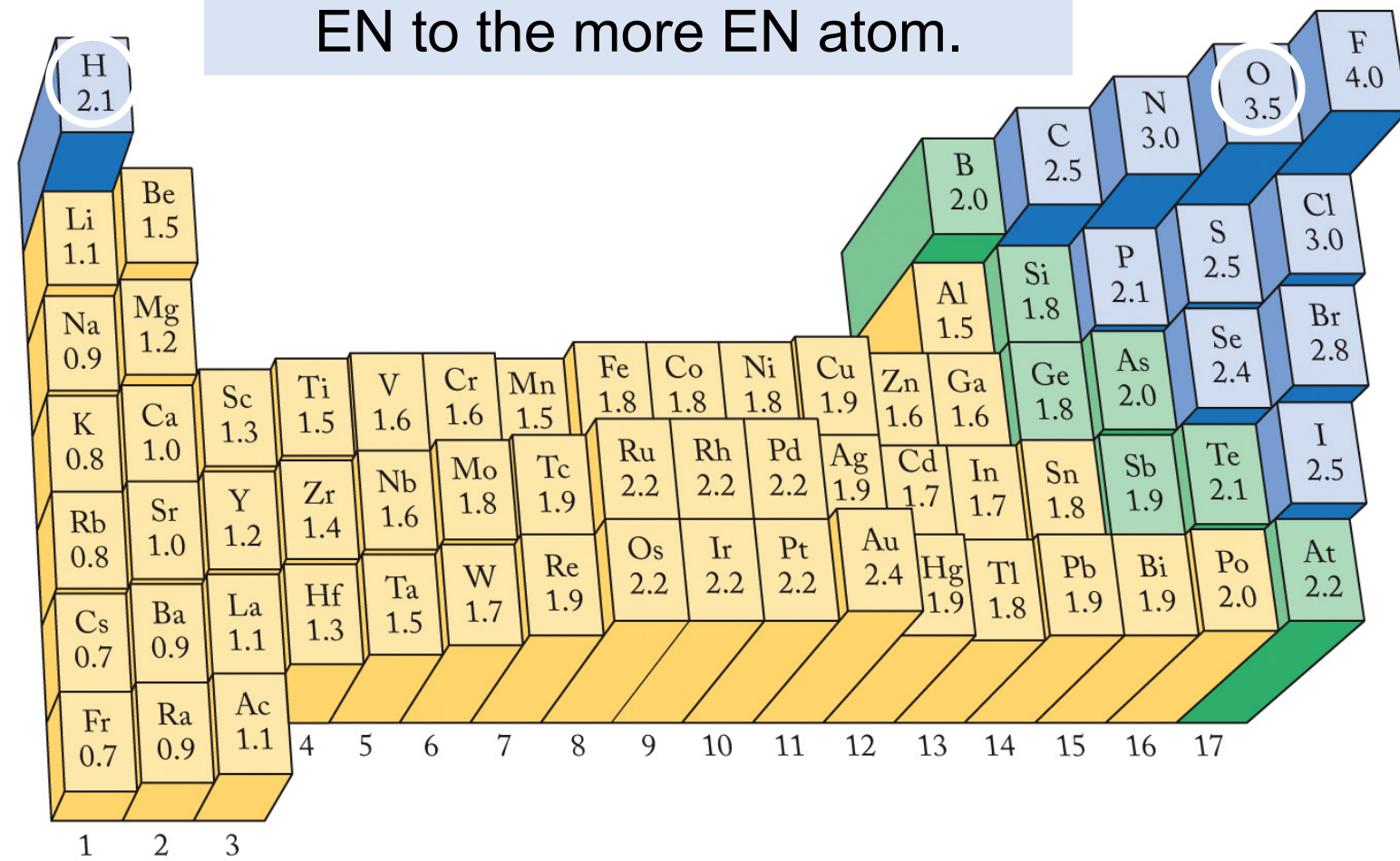

## BOND POLARITY

An unequal sharing of electrons in a bond when difference in EN ( $\Delta EN$ ) is large.

Draw the **bond dipoles** for water:

## BOND DIPOLE

An arrow pointing from the less EN to the more EN atom.

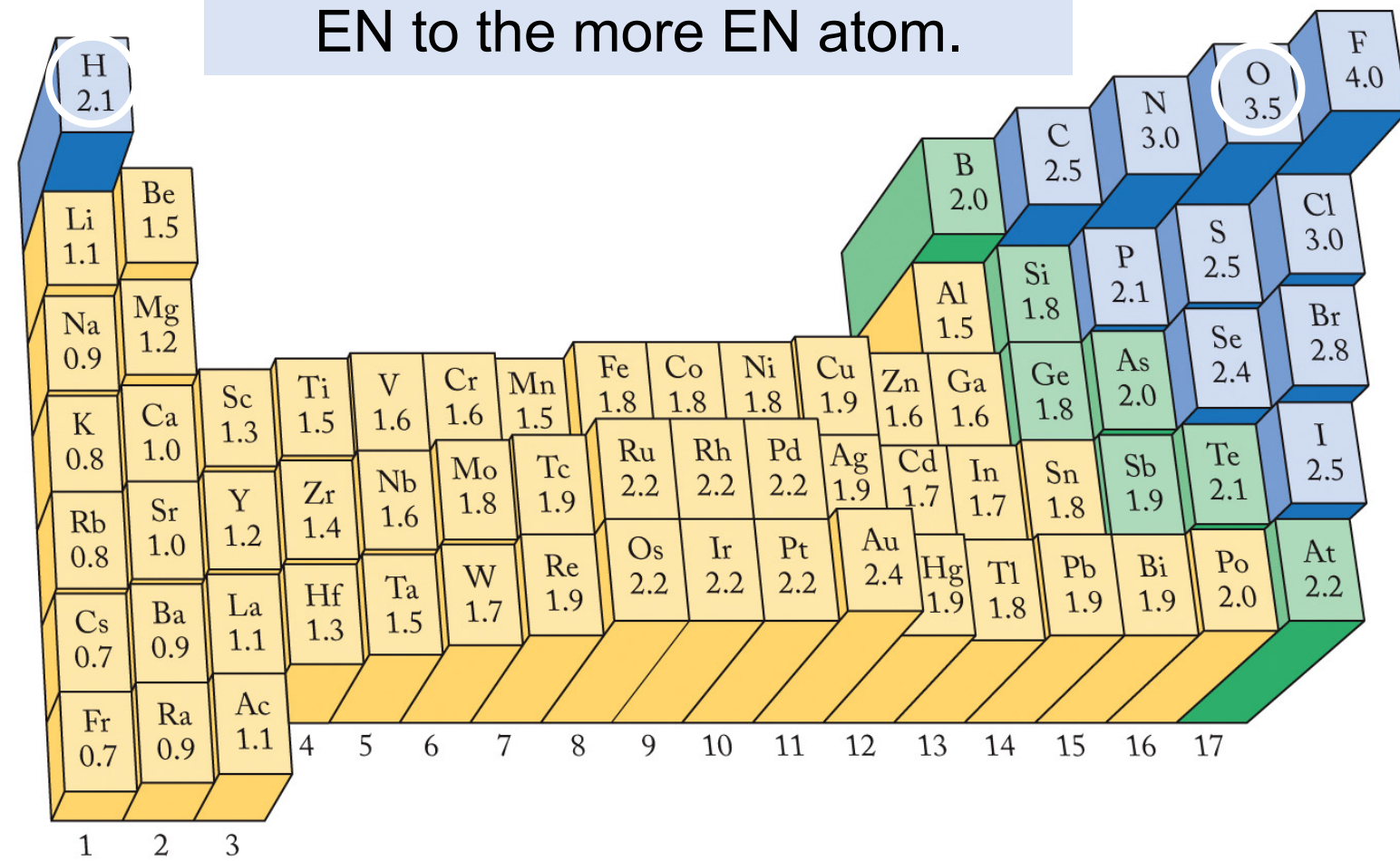

## BOND POLARITY

An unequal sharing of electrons in a bond when difference in EN ( $\Delta EN$ ) is large.

Draw the **bond dipoles** for water:

*Use the molecular geometry not the Lewis structure!*

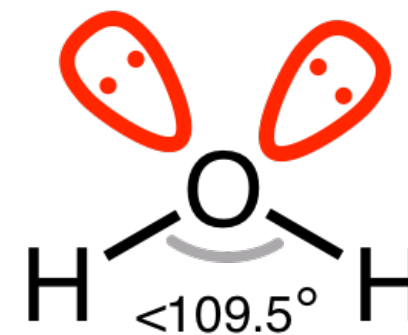

## BOND DIPOLE

An arrow pointing from the less EN to the more EN atom.

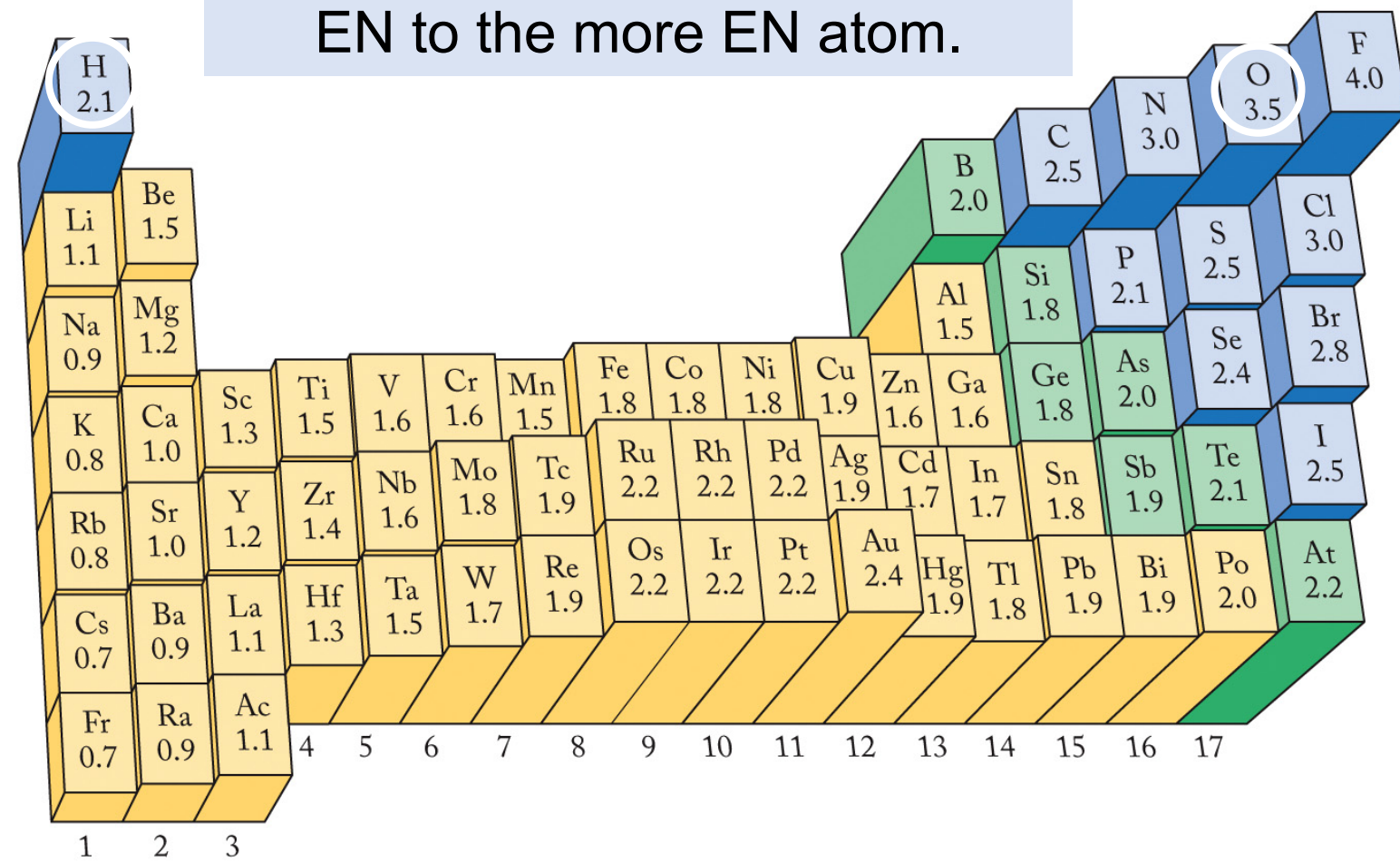

## BOND POLARITY

An unequal sharing of electrons in a bond when difference in EN ( $\Delta EN$ ) is large.

Draw the **bond dipoles** for water:

Use the molecular geometry not the Lewis structure!

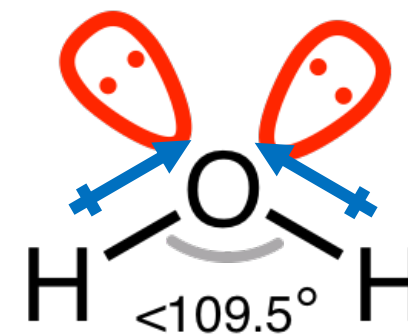



## BOND DIPOLE

An arrow pointing from the less EN to the more EN atom.

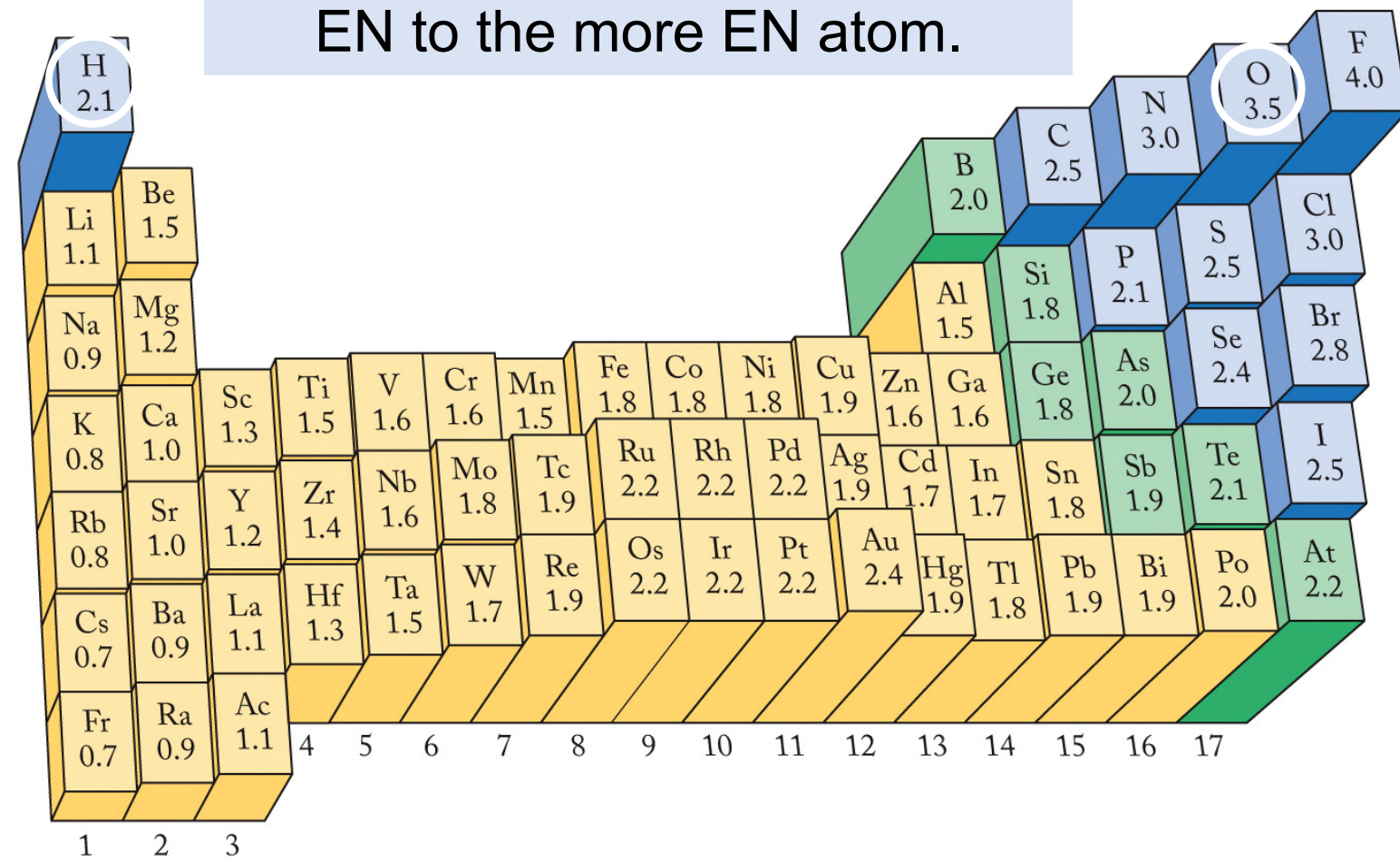

## BOND POLARITY

An unequal sharing of electrons in a bond when difference in EN ( $\Delta EN$ ) is large.

Draw the **bond dipoles** for water:

Use the molecular geometry not the Lewis structure!

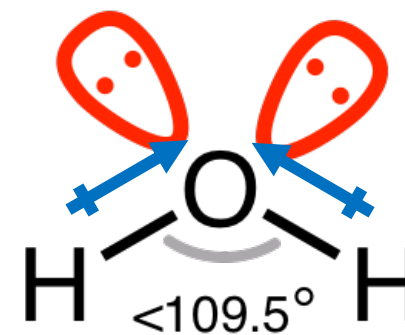

*Is water polar?*

## BOND DIPOLE

An arrow pointing from the less EN to the more EN atom.

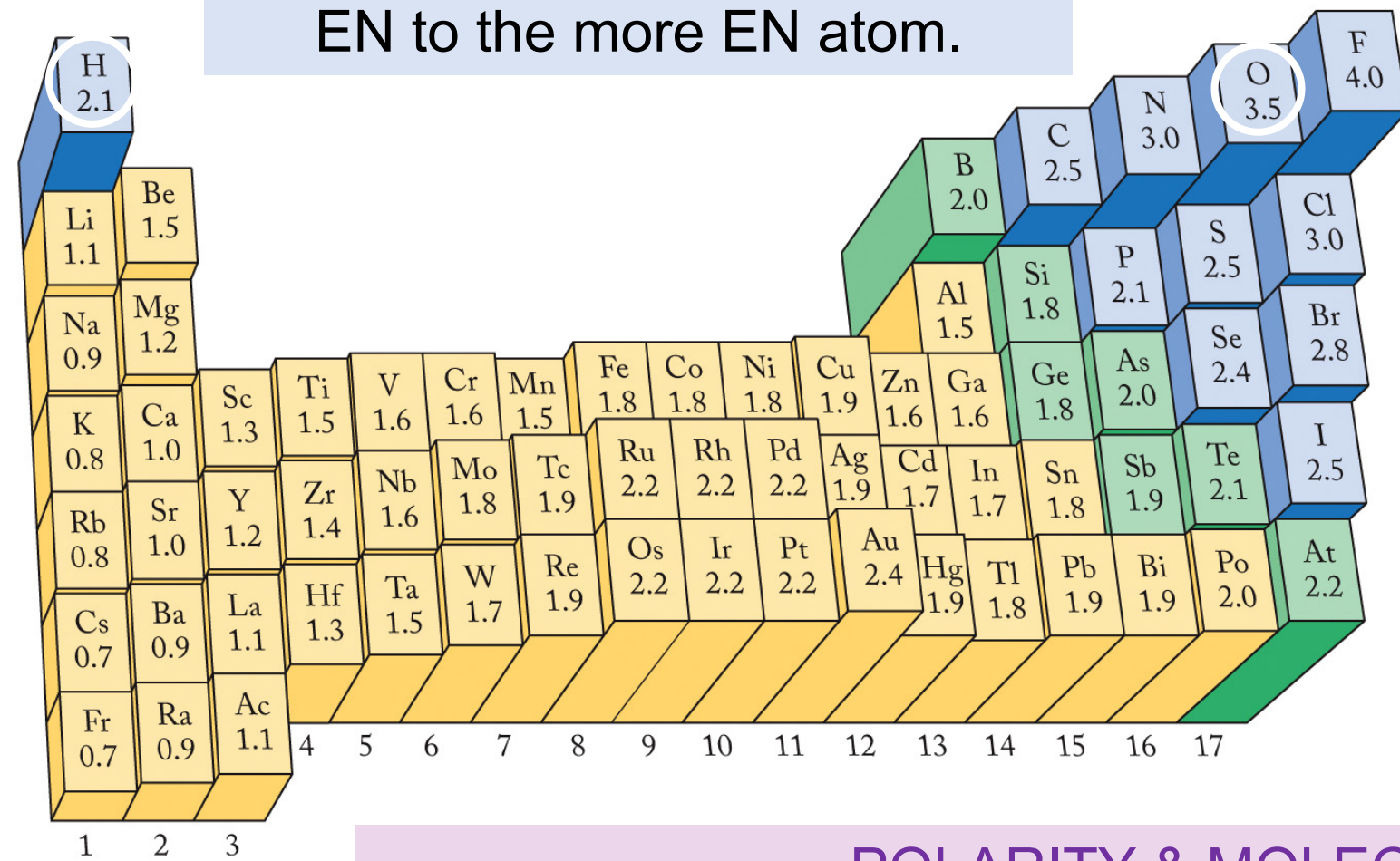

## BOND POLARITY

An unequal sharing of electrons in a bond when difference in EN ( $\Delta EN$ ) is large.

Draw the **bond dipoles** for water:

Use the molecular geometry not the Lewis structure!

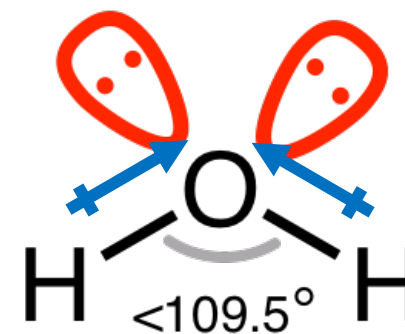

*Is water polar?*

## POLARITY & MOLECULAR DIPOLE

The sum of the bond dipoles in a molecule determines if it is **polar**.

## BOND DIPOLE

An arrow pointing from the less EN to the more EN atom.

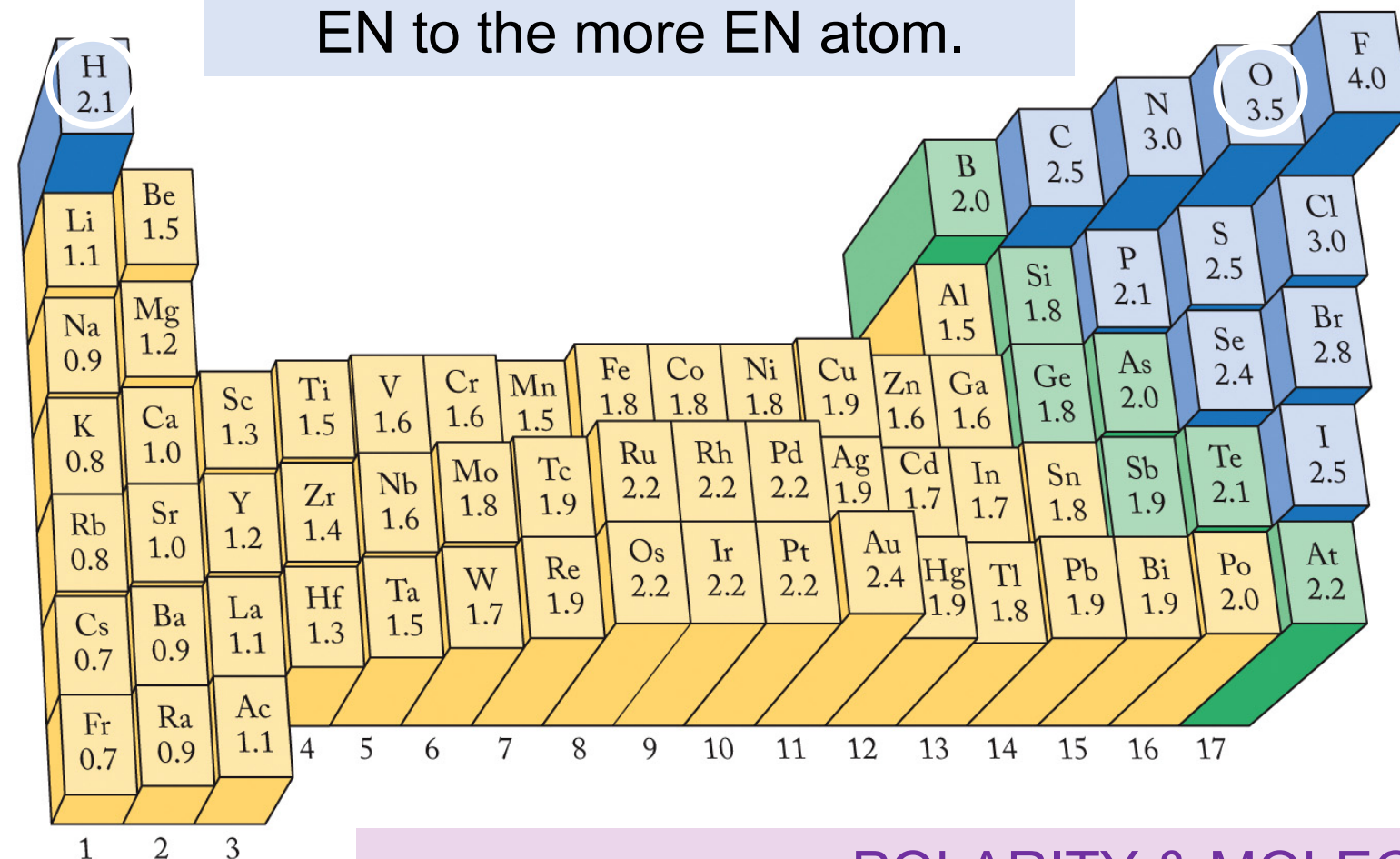

## BOND POLARITY

An unequal sharing of electrons in a bond when difference in EN ( $\Delta EN$ ) is large.

Draw the **bond dipoles** for water:

Use the molecular geometry not the Lewis structure!

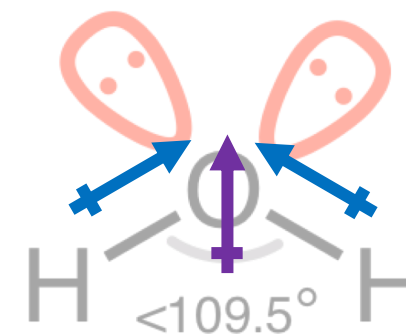

Is water polar? **YES!**

## POLARITY & MOLECULAR DIPOLE

The sum of the bond dipoles in a molecule determines if it is **polar**.

For each, draw the **bond dipoles**:

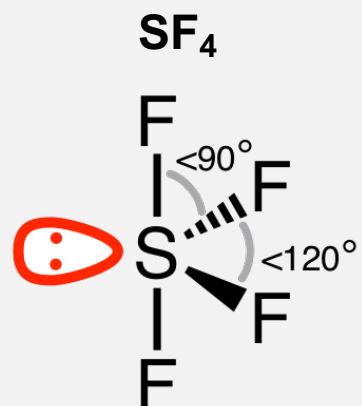

SN = 5, see-saw

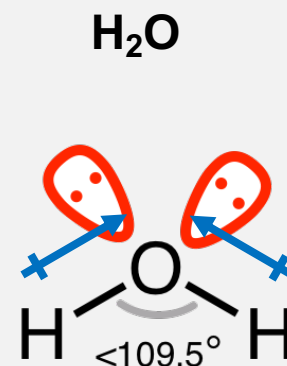

SN = 4, bent

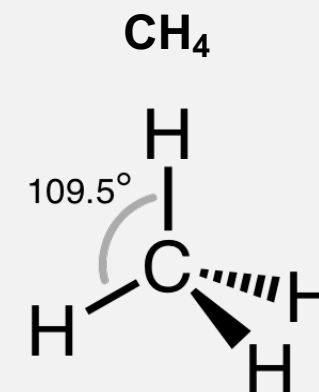

SN = 4, tetrahedral

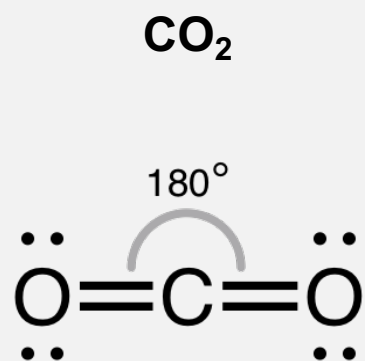

SN = 2, linear

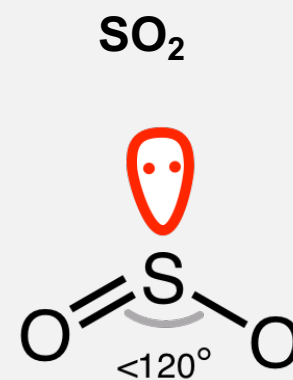

SN = 3, bent

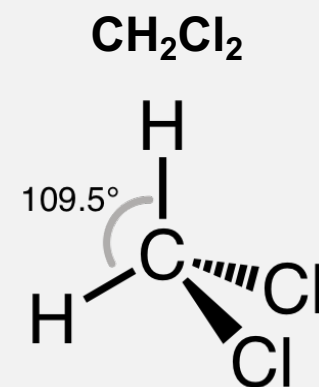

SN = 4, tetrahedral

For each, draw the **bond dipoles**:

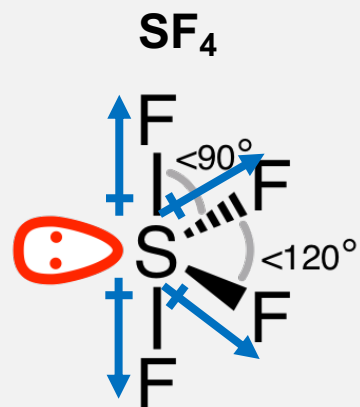

SN = 5, see-saw

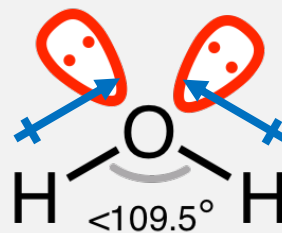
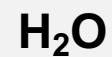

SN = 4, bent

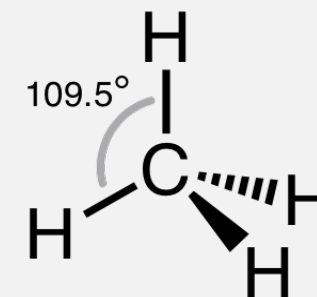

SN = 4, tetrahedral

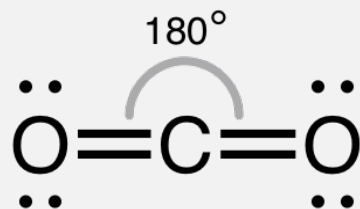

SN = 2, linear

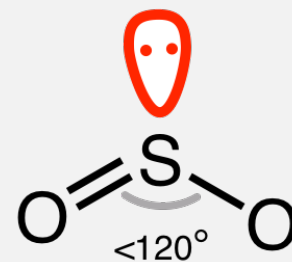

SN = 3, bent

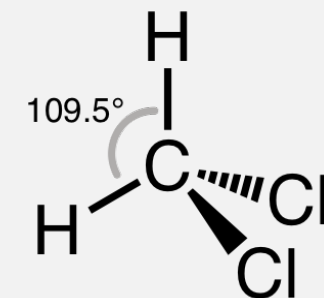
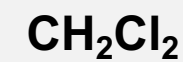

SN = 4, tetrahedral

For each, draw the **bond dipoles**:

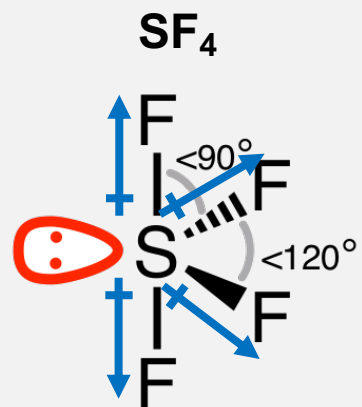

SN = 5, see-saw

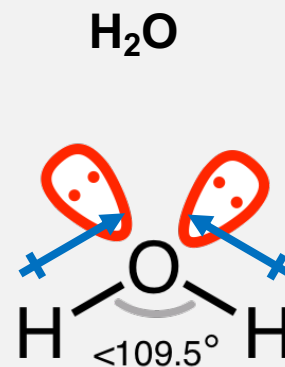

SN = 4, bent

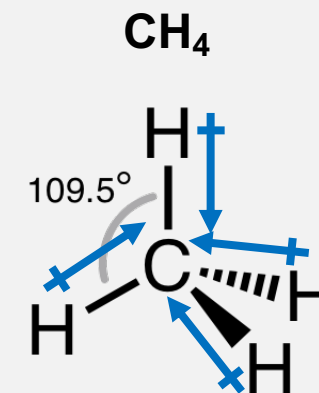

SN = 4, tetrahedral

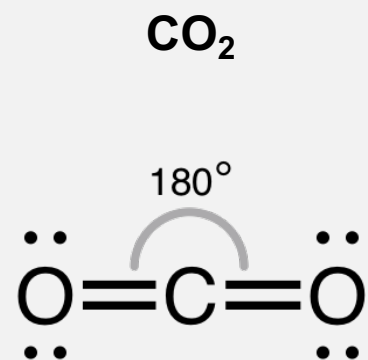

SN = 2, linear

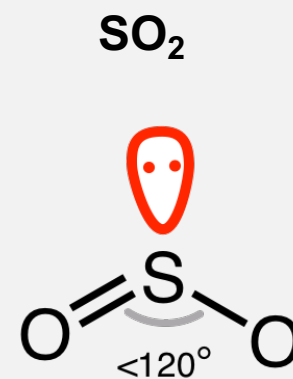

SN = 3, bent

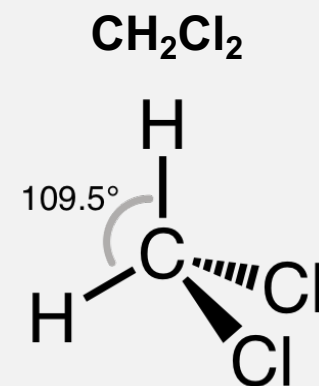

SN = 4, tetrahedral

For each, draw the **bond dipoles**:

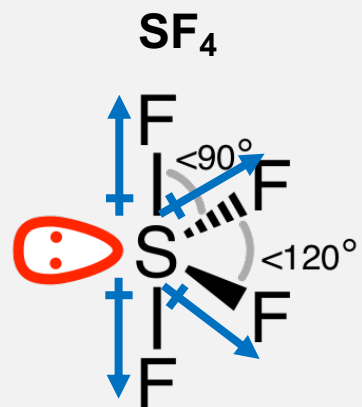

SN = 5, see-saw

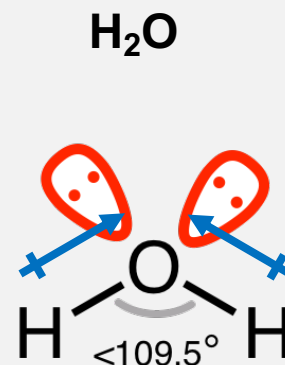

SN = 4, bent

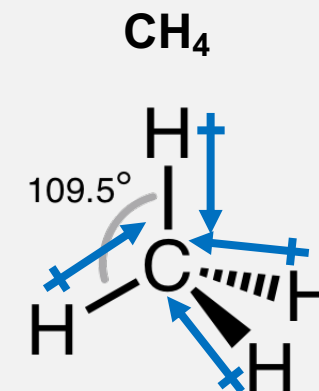

SN = 4, tetrahedral

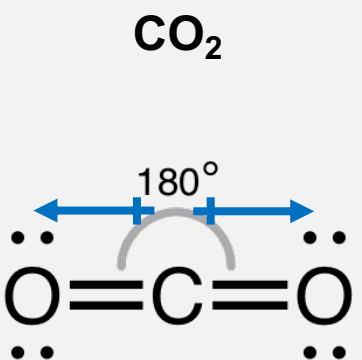

SN = 2, linear

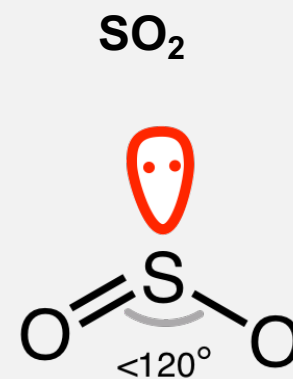

SN = 3, bent

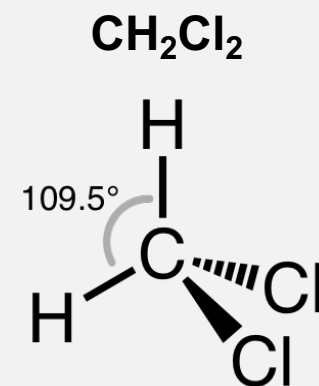

SN = 4, tetrahedral

For each, draw the **bond dipoles**:

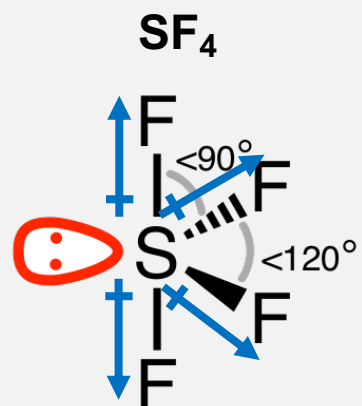

SN = 5, see-saw

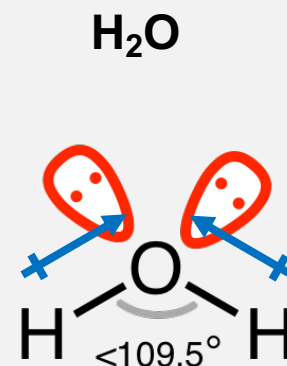

SN = 4, bent

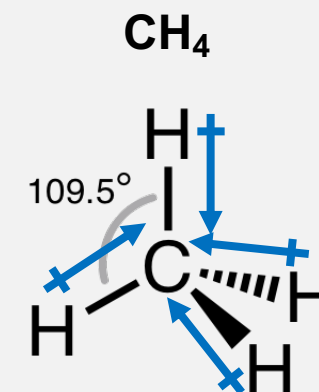

SN = 4, tetrahedral

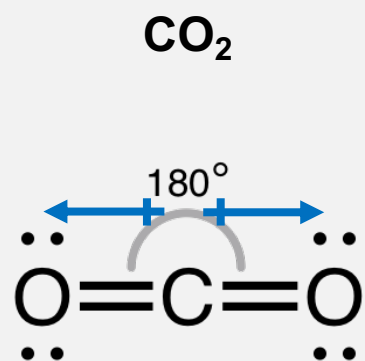

SN = 2, linear

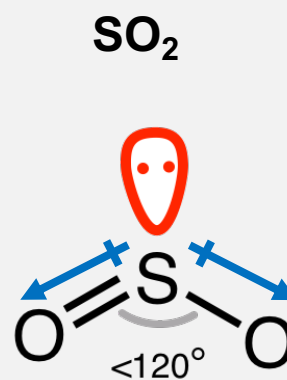

SN = 3, bent

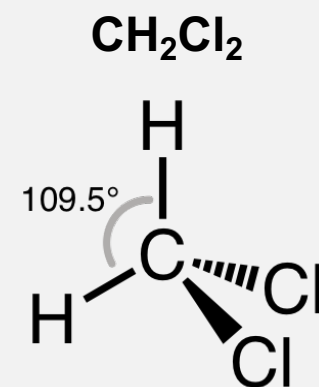

SN = 4, tetrahedral



For each, draw the **bond dipoles**:

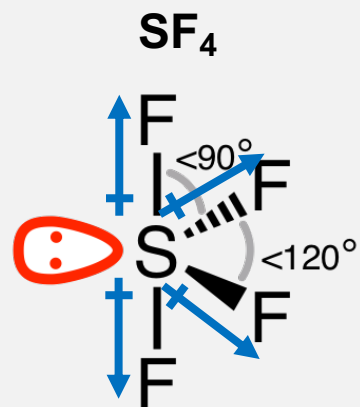

SN = 5, see-saw

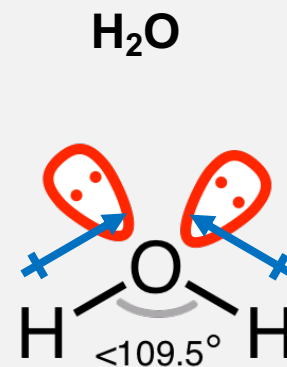

SN = 4, bent

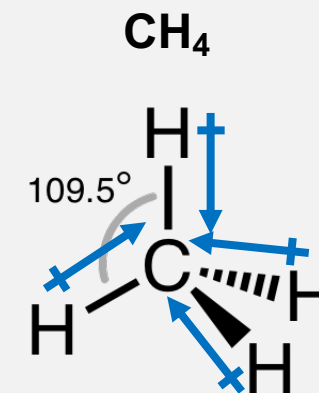

SN = 4, tetrahedral

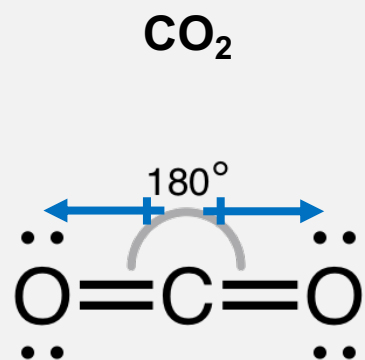

SN = 2, linear

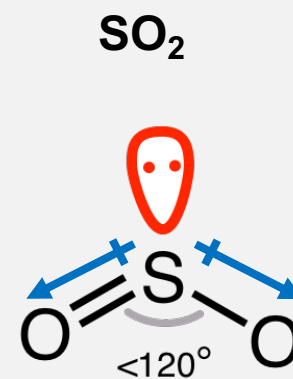

SN = 3, bent

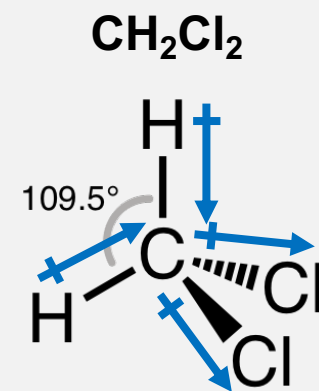

SN = 4, tetrahedral

For each, determine if **polar** and draw the **molecular dipoles**:

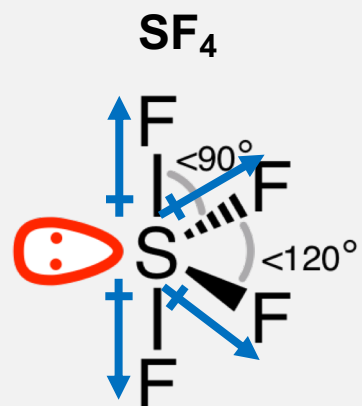

SN = 5, see-saw

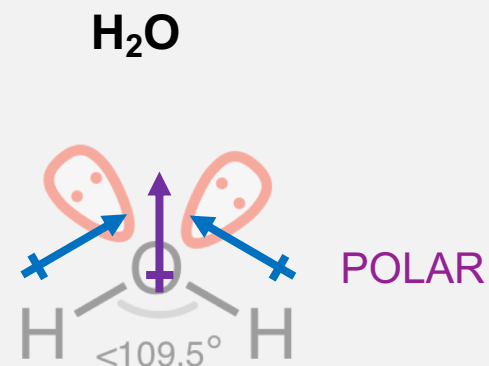

SN = 4, bent

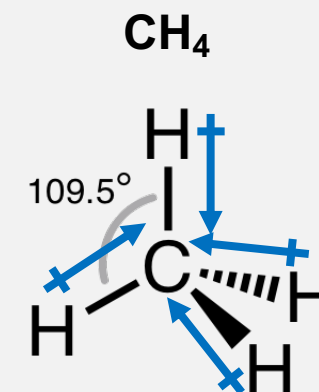

SN = 4, tetrahedral

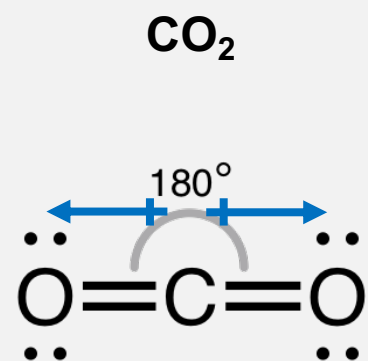

SN = 2, linear

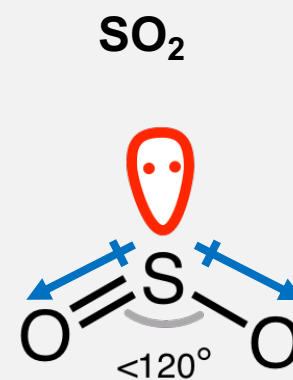

SN = 3, bent

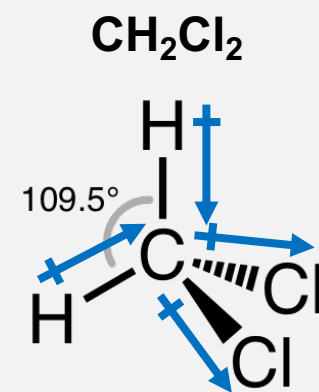

SN = 4, tetrahedral

For each, determine if **polar** and draw the **molecular dipoles**:

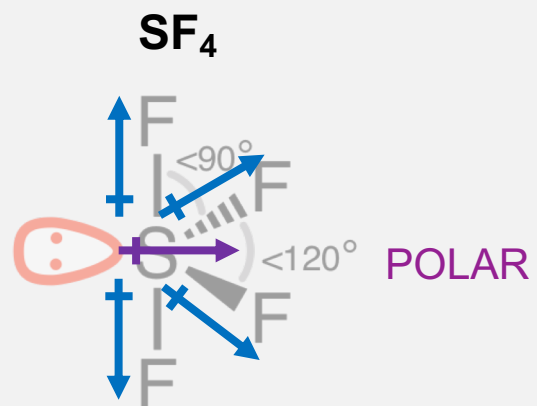

SN = 5, see-saw

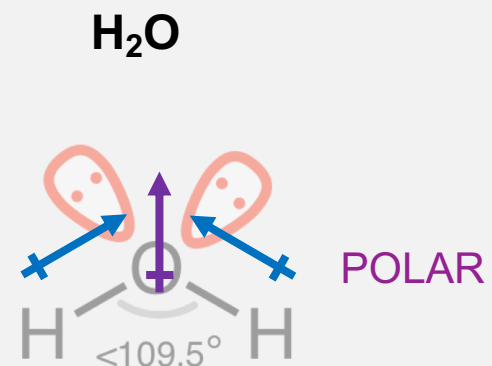

SN = 4, bent

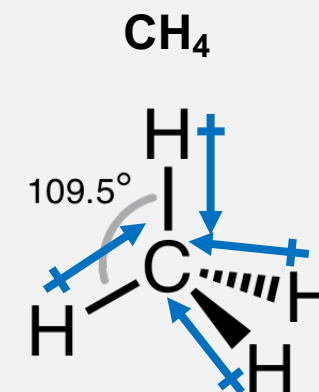

SN = 4, tetrahedral

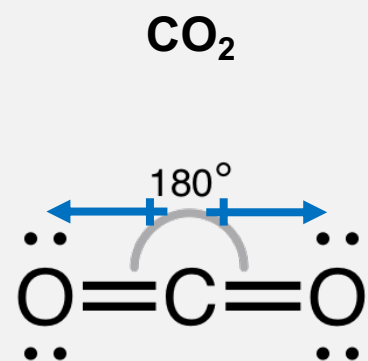

SN = 2, linear

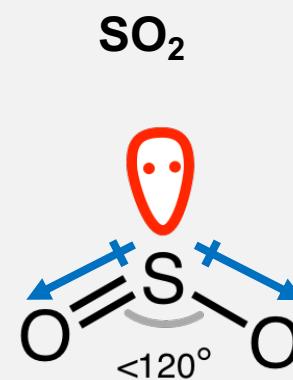

SN = 3, bent

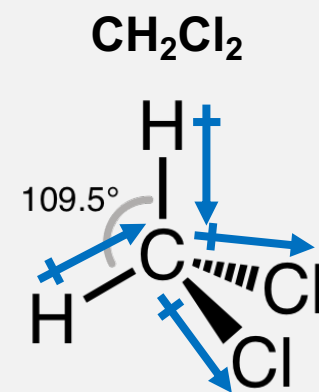

SN = 4, tetrahedral

For each, determine if **polar** and draw the **molecular dipoles**:

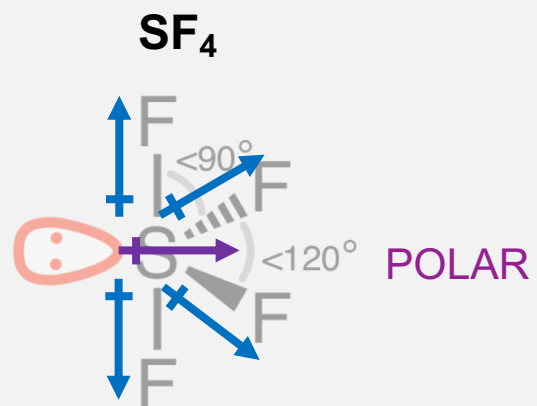

SN = 5, see-saw

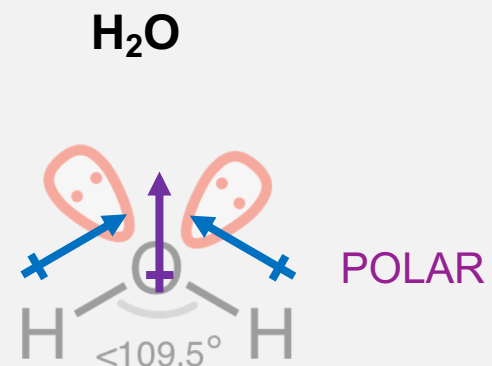

SN = 4, bent

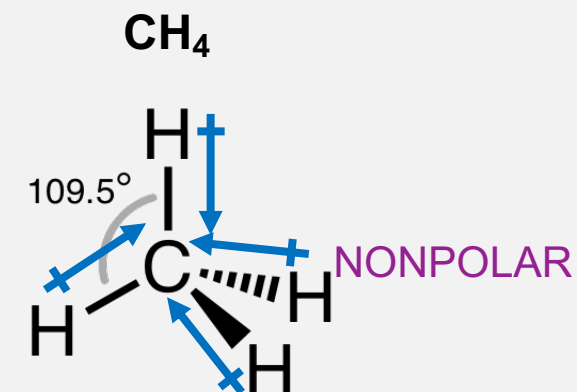

SN = 4, tetrahedral

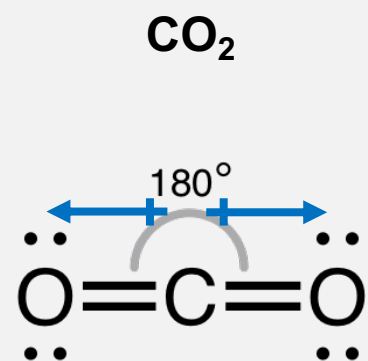

SN = 2, linear

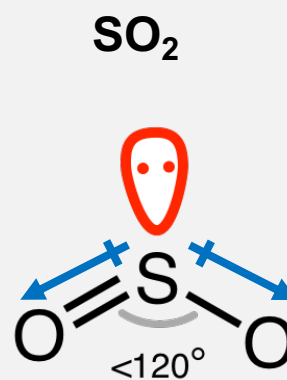

SN = 3, bent

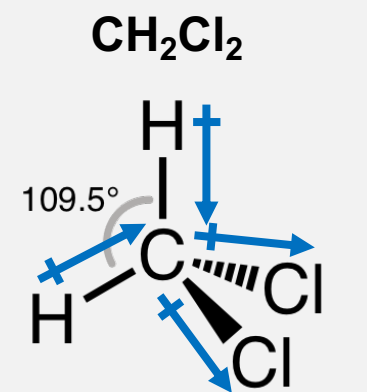

SN = 4, tetrahedral

For each, determine if **polar** and draw the **molecular dipoles**:

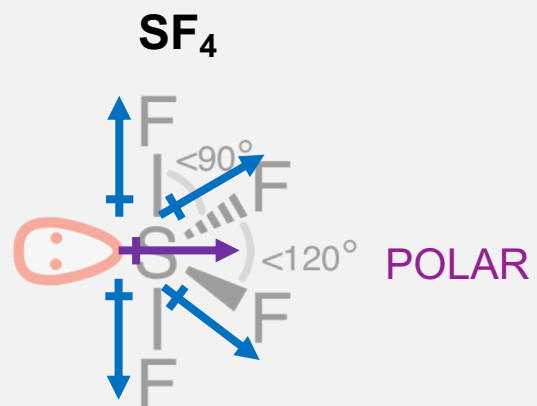

SN = 5, see-saw

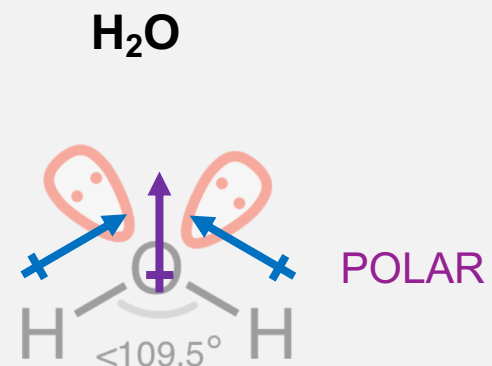

SN = 4, bent

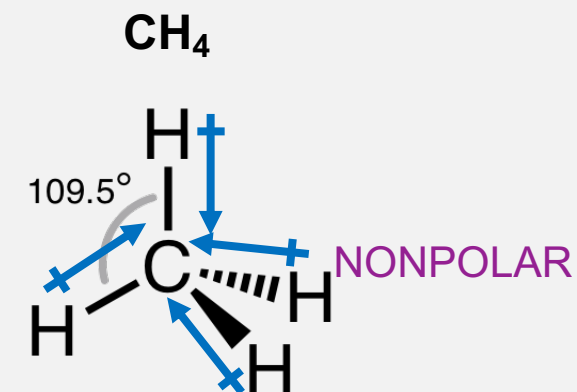

SN = 4, tetrahedral

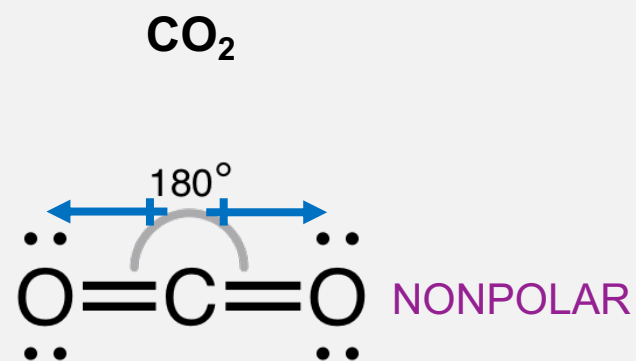

SN = 2, linear

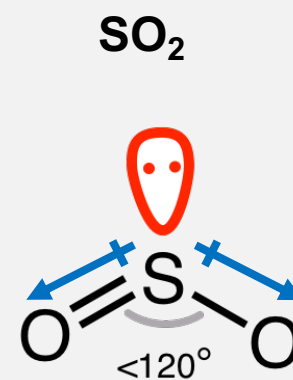

SN = 3, bent

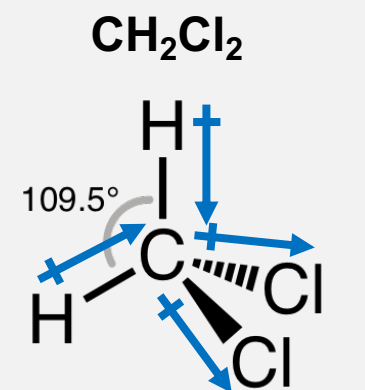

SN = 4, tetrahedral

For each, determine if **polar** and draw the **molecular dipoles**:

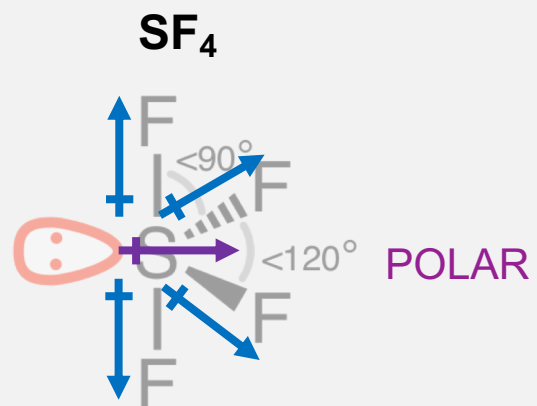

SN = 5, see-saw

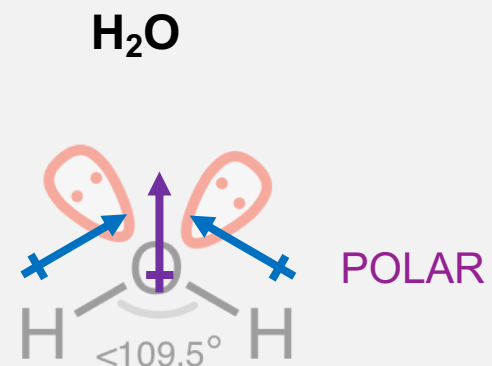

SN = 4, bent

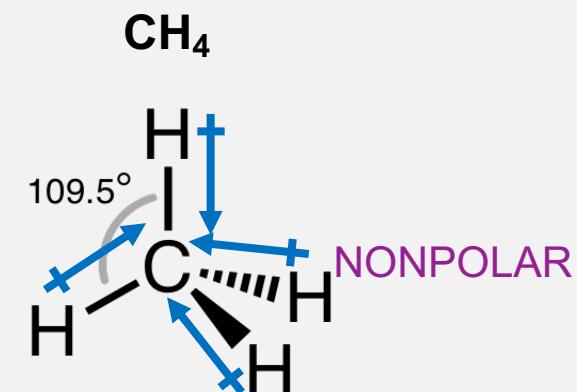

SN = 4, tetrahedral

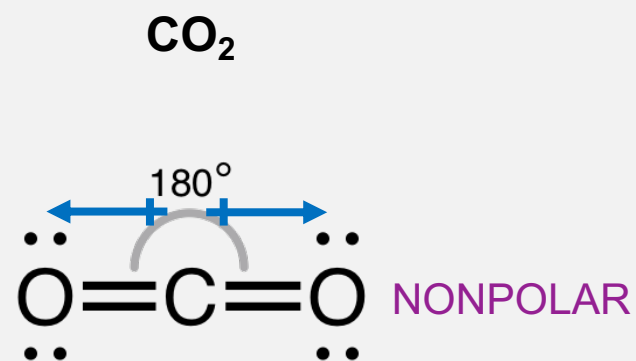

SN = 2, linear

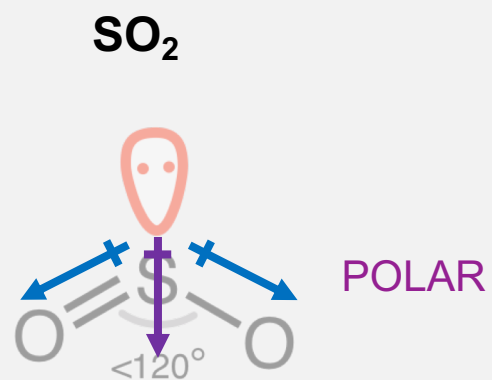

SN = 3, bent

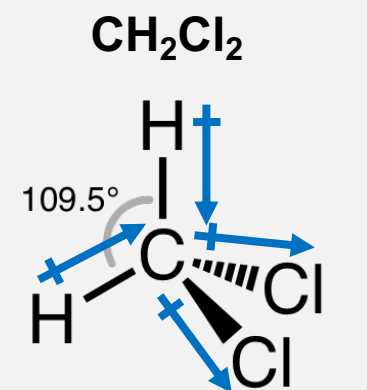

SN = 4, tetrahedral

For each, determine if **polar** and draw the **molecular dipoles**:

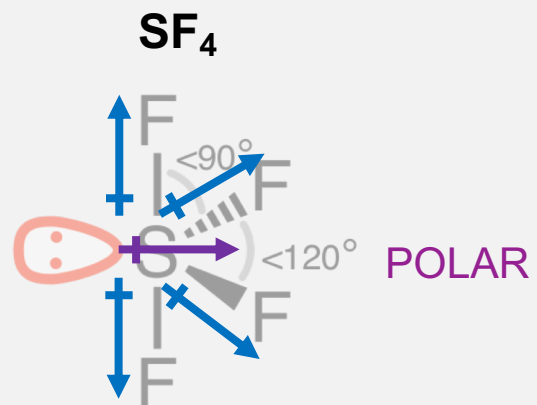

SN = 5, see-saw

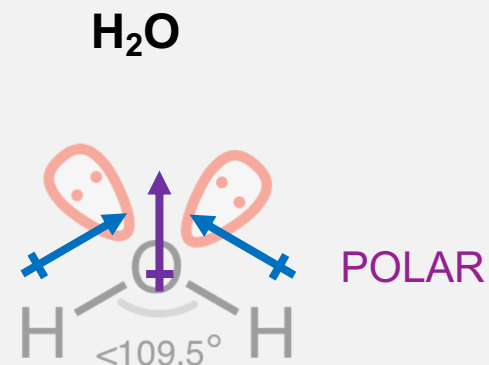

SN = 4, bent

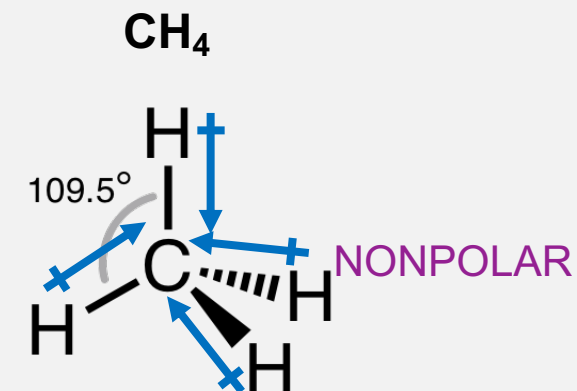

SN = 4, tetrahedral

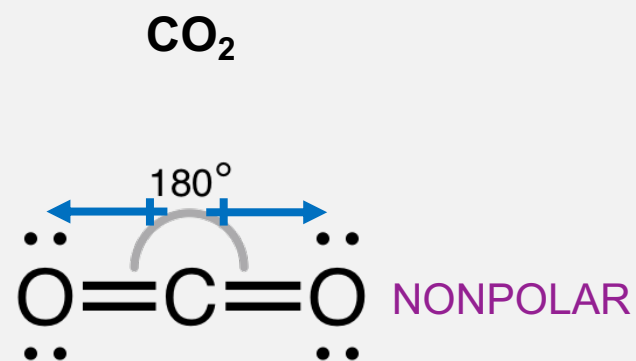

SN = 2, linear

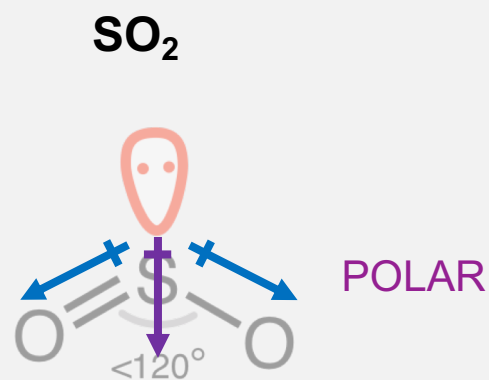

SN = 3, bent

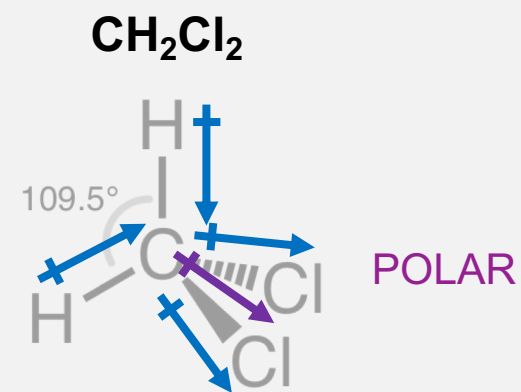

SN = 4, tetrahedral